

Trans-Cal Industries, Inc.

Model ATS-400

Altitude Reporting Equipment
Test Set & Simulator
Operating Manual



Trans-Cal Industries, Inc.
16141 Cohasset Street
Van Nuys, CA 91406-2908
(800) 423-2913*(818) 787-1221*(818) 787-8916FAX

10 August 2006

Document Number: 104010

Rev. E

Proprietary Information:

This document contains proprietary information, which may not be reproduced, transmitted, or copied without the prior written consent of Trans-Cal Industries, Inc.

©2004 by Trans-Cal Industries, Inc. All rights reserved.

Contact Information:

Trans-Cal Industries, Inc.
16141 Cohasset Street
Van Nuys, CA 91406-2908

Phone: 818/787-1221
Toll Free: 800/423-2913
FAX 818/787-8916
www.trans-cal.com

Ordering Information:

To receive additional copies of this publication order part number 104010 rev. D, *Model ATS-400 Altitude Reporting Equipment Test Set & Simulator Operating Manual*

Prepared by: M. Remenih 19 August 2004

Checked by: J. Ferrero III 19 August 2004

Approved by: J. Ferrero 19 August 2004

History of Revision

Revision	Date	Description
A	4 March 2004	Prototype release.
B	27 May 2004	Production release.
C	19 August 2004	Updated Production release.
D	14 September 2004	Add wiring harness diagram.
E	10 August 2006	Updated manual, added warranty

Materials referenced within this document:

ARINC Specification 429, Published 1 September 1995.
TIA/EIA Recommended Standard RS232D, Published January 1987.
TIA/EIA Recommended Standard RS422B, Published May 1994.
TIA/EIA Recommended Standard RS485A, Published March 1998.

Table of Contents

Table of Contents	3
Abbreviations and Symbols	4
Introduction & Equipment Description	5
Section 1.0 Specifications	6
Section 2.0 Operation.....	7
2.1 Test Condition One: Standard ICAO Altitude Encoder	7
Figure 1	8
2.2 Test Condition Two: ICAO Altitude Encoder with RS232 Port	9
Figure 2	10
Section 3.0 Front Panel Connector Pin Assignments	11
Section 4.0 Power Connections	14
Figure 3	14
Section 5.0 Front Panel Switch Functions	15
Section 6.0 Front Panel Rotary Switch Functions	16
Section 7.0 Serial Interface Specifications	17
7.1 General Characteristics of Serial Data Inputs	17
7.2 ARINC 429 Label 203 Protocol	18
7.3 ARNAV PROTOCOL	20
7.4 MAGELLAN PROTOCOL	21
7.5 NORTHSTAR PROTOCOL	22
7.6 SHADIN PROTOCOL	23
7.7 TRIMBLE/GARMIN PROTOCOL.....	24
7.8 UPS AT PROTOCOL.....	25
7.9 UPS AT LORAN 618 PROTOCOL.....	26
7.10 Serial Data Matrix.....	27
Section 8.0 Simulation Mode.....	28
Wiring Harness Diagram for the ATS-400 Test Set.....	30
WARRANTY REGISTRATION	31

Abbreviations and Symbols

A	Amperes
AC	Advisory Circular
ARINC	Aeronautical Radio Incorporated
ASCII	American Standard for Coded Information Interchange
ATCRBS	Air Traffic Control Radar Beacon System
bps	Bits per second.
EEPROM	Electrically Erasable Read Only Memory
EIA	Electronic Industries Association
FAA	Federal Aviation Administration
FAR	Federal Aviation Regulation
ft.	Distance in feet.
GPS	Global Positioning System
Hz	Hertz
ICAO	International Civil Aviation Organization
I.F.F.	Identification Friend or Foe
In. Hg.	Inches of Mercury
Kbps	Kilobits per Second
KHz	Kilohertz
LSB	Least Significant Bit
mA	Milliamperes
max.	Maximum
MB	Millibar
MHz	Megahertz
MFD	Multi-Function Display
MSL	Mean Sea Level
min.	Minimum
ms	Time in milliseconds.
MSB	Most Significant Bit
NIST	National Institute of Standards and Technology
oz	Ounce
psi	Pounds per Square Inch
RAM	Random Access Memory
RS	Recommended Standard
RTCA	RTCA Inc. (formerly Radio Technical Commission for Aeronautics.)
SAE	Society of Automotive Engineers
sec.	Time in seconds.
SSM	Sign, Status Matrix
SSR	Secondary Surveillance Radar
TCI	Trans-Cal Industries, Inc.
TIA	Telecommunication Industries Association
TSO	Technical Standard Order
UUT	Unit Under Test
Vdc	Volts Direct Current
VSI	Vertical Speed Indicator
Ω	Electrical resistance measured in Ohms.
°C	Temperature in degrees centigrade.
±	Plus or minus.
§	Section
↓	Line Feed
←	Carriage Return.
▶	Start of message character.
◀	End of message character.

Introduction & Equipment Description

The TCI Model ATS-400 is designed to test, display and simulate the output of Altitude Reporting Equipment, which conform to the ICAO Standard for SSR Pressure Altitude Transmission. In accordance with the U.S. National Standards for I.F.F. Mark X (SIF)/Air Traffic Control Radar Beacon System SIF/ATCRBS. The ATS-400 will also display the output of altitude reporting equipment which transmit serial data in either RS232, RS422, RS485 or ARINC 429 Label 203.

The ATS-400 utilizes an advanced RISC microprocessor to display the output of these devices in both numeric and binary forms, with an input altitude data range covering the full ICAO code from -1000 to +126,000 feet. The ATS-400 may be interfaced with an IBM PC for cross-reference and two-way data communication if required.

The ATS-400 can also function in a simulate mode providing altitude data on the ICAO simulate port (connector J1) and RS232 altitude data on a serial data port (connector J4). In this mode, the test set will output altitude data beginning at -1000 feet, then ascend at 6000 feet per minute to 126,000 feet. The ascent may be halted at any altitude by depressing the simulate toggle. The ascending count may be resumed by depressing the simulate toggle again. The ATS-400 in simulate mode, provides the avionics technician with a known good ICAO altitude code source for testing altitude inputs to transponders, GPS, MFD, auto-pilots and other navigation devices.

The ATS-400 may be used in the aircraft or on the bench making this an extremely versatile piece of test equipment.

Section 1.0 Specifications

Electrical	
Input Voltage	+7.5 to 35Vdc
Input Current	400mA Max.
Internal Fuse	2A fast blow.
Physical	
Height with cover.	6.16"
Width	5.68"
Length	10.0"
Weight	3.5 lbs.
Environmental	
Operating temp.	0° to +50°C
Storage temp.	-20° to +65°C
Humidity	90% Non-Condensing at 50°C.
ICAO Input Port (Connector P1)	
Pull-Up Voltage	+5Vdc
Sink Current	2.5mA
Code Format	ICAO Altitude Transmission SIF/ATCRBS
ICAO Simulate Port (Connector J1)	
Driver Description	"Uncommitted" collectors of 11 discreet transistors.
"Pull-Up" Voltage	+3 to +40Vdc
Max. "Sink" Current	50mA
Code Format	ICAO Altitude Transmission SIF/ATCRBS
RS232 Input Port (Connector J4)	
Electrical Format	TIA/EIA RS-232
Max. Input Voltage	±15Vdc
Impedance	3K to 7KΩ
Data Rate	1200 to 9600bps
RS232 Simulate Port (Connector J2 Pin 13)	
Electrical Format	TIA/EIA RS-232
Max. Output Voltage	±25Vdc
Impedance	3K to 7KΩ
Data Rate	1200 to 9600bps
RS422/485 Input Port (Connector J2)	
Electrical Format	TIA/EIA RS-422 & 485
Max. Input Voltage	-7 to +12Vdc
Impedance	12KΩ Min.
Data Rate	1200 to 9600bps
ARINC 429 Input Port (Connector J3)	
Electrical Format	ARINC 429 (DITS)
Max. Input Voltage	+1.5 to +13Vdc
Impedance	30KΩ Min.
Data Rate	12.5kbps

Section 2.0 Operation

The ATS-400 is a versatile piece of test equipment, and it would not be practical to cover every possible test condition or set-up within this document. Therefore, only two common test conditions will be described. Please contact the factory for assistance if required.

2.1 Test Condition One: Standard ICAO Altitude Encoder

1. Turn the ATS-400 UUT Power switch to the OFF position.
2. Connect a vacuum/pressure source and control as required.
3. Construct a wiring harness between the altitude encoder and connector P1 of the ATS-400. The P1 connector pin assignments are listed in §3.0. See **figure 1**. Refer to the altitude encoder installation manual for specific connector pin assignments.
4. Provide +14 to 28Vdc power to the ATS-400 five-way binding post.
5. Turn the ATS-400 power switch to “AIRCRAFT.” This switch directs the ATS-400 to receive its power from the five-way binding posts.
6. Move the Strobe switch to the “ON” position. This applies a ground to pin 6 of the P1 connector, enabling the altitude encoder’s outputs.
7. Energize the altitude encoder and the ATS-400 by turning the ATS-400 “UUT Power” switch to either +14Vdc for 14-volt operation or +28Vdc for 28-volt operation. Selecting the +28Vdc position will direct power to the ATS-400 electronics and to Pin 8 of the P1 connector. Selecting the +14Vdc position will provide power to the ATS-400 electronics and to pin 14 of connector P1. ***CAUTION! ENSURE THAT POWER IS APPLIED TO THE CORRECT ALTITUDE ENCODER CONNECTOR PIN! ENCODER DAMAGE MAY RESULT!***
8. After an initialization message, the ICAO altitude data should be presented on the bottom line of the two-line display. The top line will display a no serial data input message. Apply vacuum or pressure as required to verify the operation of the unit under test.

Figure 1

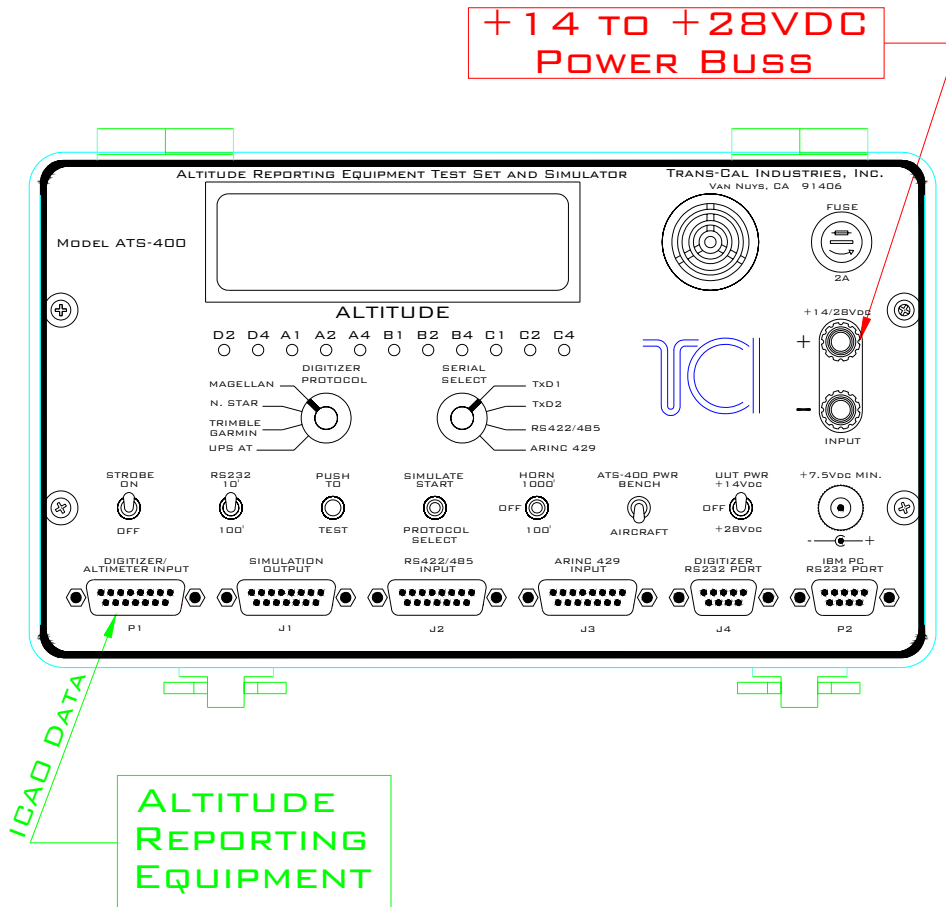

2.2 Test Condition Two: ICAO Altitude Encoder with RS232 Port

1. Turn the ATS-400 UUT power switch to the OFF position.
2. Connect a vacuum/pressure source and control as required.
3. Construct a wiring harness between the altitude encoder and connector P1 of the ATS-400. Construct a wiring harness between the RS232 port of the altitude reporting device and connector J4 of the ATS-400. The P1 and J4 connector pin assignments are listed in §3.0. See **figure 2**. Refer to the altitude encoder installation manual for specific connector pin assignments.
4. Provide +14 to 28Vdc power to the ATS-400 five-way binding post.
5. Turn the ATS-400 power to “AIRCRAFT.” This switch directs the ATS-400 to receive its power from the five-way binding posts.
6. Rotate the Serial Select Switch to direct the serial data into the processor. See § 6.0 for a description of switch functions.
7. Rotate the Digitizer Protocol Switch to select the altitude digitizer protocol. See § 6.0 for a description of switch functions. See § 7.0 for a description of serial altitude data protocols.
8. Energize the altitude encoder and the ATS-400 by turning the ATS-400 “UUT Power” switch to either +14Vdc for 14-volt operation or +28Vdc for 28-volt operation. Selecting the +28Vdc position will direct power to the ATS-400 electronics and to Pin 8 of the P1 connector. Selecting the +14Vdc position will provide power to the ATS-400 electronics and to pin 14 of connector P1.
9. After an initialization message, the ICAO altitude data should be presented on the bottom line and the serial data on the top line of the two-line display. Apply vacuum or pressure as required to verify the operation of the unit under test. See **Figure 2**.

Figure 2

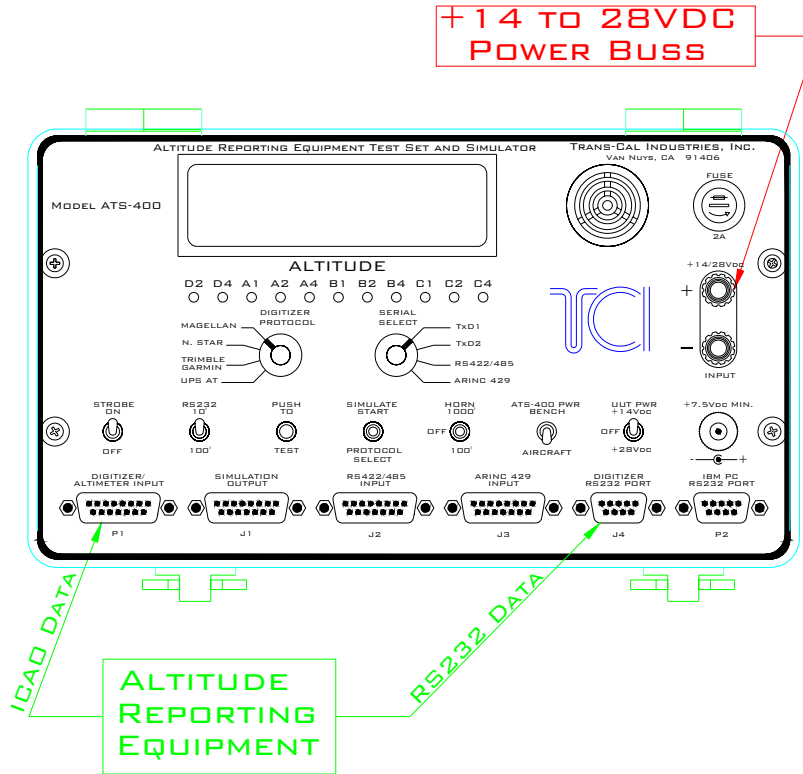

Section 3.0 Front Panel Connector Pin Assignments

Connector P1 Digitizer/Altimeter Input

Front panel connector DA-15S, mating connector DA-15P.

Pin	I/O	Connection	Function
1	I	D4	ICAO Altitude data bit input.
2	I	A1	ICAO Altitude data bit input.
3	I	A2	ICAO Altitude data bit input.
4	I	A4	ICAO Altitude data bit input.
5	I	B1	ICAO Altitude data bit input.
6	O	Strobe	ICAO Data enable control, front panel strobe switch, low to enable.
7	I	D2	ICAO Altitude data bit input.
8	O	+28Vdc	Digitizer/Altimeter Power
9	I	B2	ICAO Altitude data bit input.
10	I	B4	ICAO Altitude data bit input.
11	I	C1	ICAO Altitude data bit input.
12	I	C4	ICAO Altitude data bit input.
13	I	C2	ICAO Altitude data bit input.
14	O	+14Vdc	Digitizer/Altimeter Power
15	O	Ground	Power Ground

Connector J1 Simulation Output

Front panel connector DA-15P, mating connector DA-15S.

Pin	I/O	Connection	Function
1	O	D4	ICAO Altitude data bit output.
2	O	A1	ICAO Altitude data bit output.
3	O	A2	ICAO Altitude data bit output.
4	O	A4	ICAO Altitude data bit output.
5	O	B1	ICAO Altitude data bit output.
6	I	Strobe	ICAO Data enable control, low to enable. Pull high or open to disable.
7	O	D2	ICAO Altitude data bit output.
8	⊗	-	Open pin. No internal connection.
9	O	B2	ICAO Altitude data bit output.
10	O	B4	ICAO Altitude data bit output.
11	O	C1	ICAO Altitude data bit output.
12	O	C4	ICAO Altitude data bit output.
13	O	C2	ICAO Altitude data bit output.
14	⊗	-	Open pin. No internal connection.
15	O	Ground	Power Ground

Connector J2 RS422/RS485 Input

Front panel connector DA-15P, mating connector DA-15S.

Pin	I/O	Connection	Function
1	O	Ground	Data ground.
2	O	10' Resolution	Front panel switch control, low to enable 10' resolution digitizer data.
3	O	TxD	RS232 data output from IBM PC (connector P2).
4	I	RxD1	RS232 Altitude data input to ATS-400.
5	O	Ground	Data ground
6	I	RS485/422B(+)	RS485/422B(+) Altitude data input to ATS-400.
7	I	RS485/422A(-)	RS485/422A(-) Altitude data input to ATS-400.
8	O	Ground	Data ground.
9	O	Protocol Select	Front panel switch control, low to enable.
10	O	Protocol Select	Front panel switch control, low to enable.
11		Spare	Spare.
12	I	RxD2	RS232 Altitude data input to ATS-400.
13	O	TxD	Simulate RS232 output
14		Spare	Spare.
15		Spare	Spare.

Connector J3 ARINC 429 Input

Front panel connector DA-15P, mating connector DA-15S.

Pin	I/O	Connection	Function
1	O	Ground	Data ground.
2	O	10' Resolution	Front panel switch control, low to enable 10' resolution digitizer data.
3	O	TxD	RS232 data output from IBM PC (connector P2).
4	I	RxD	RS232 Altitude data input to ATS-400.
5	O	Ground	Data ground
6		N/C	No connection.
7		N/C	No connection.
8	O	+28Vdc	Digitizer/Altimeter power.
9	O	Protocol Select	Front panel switch control, low to enable.
10	O	Protocol Select	Front panel switch control, low to enable.
11	I	429 TxA	ARINC 429 Data input to ATS-400.
12	I	429 TxB	ARINC 429 Data input to ATS-400.
13	O	Ground	Ground
14	O	+14Vdc	Digitizer/Altimeter power.
15	O	Power Ground	Power Ground.

Connector J4 RS232 Port

Front panel connector DE-9P, mating connector DE-9S.

Pin	I/O	Connection	Function
1	O	Ground	Data ground.
2	O	10' Resolution	Front panel switch control, low to enable 10' resolution digitizer data.
3	O	TxD	RS232 data output from IBM PC (connector P2).
4	I	RxD1	RS232 Altitude data input to ATS-400.
5	O	Ground	Data ground
6	O	Protocol Select	Front panel switch control, low to enable.
7	O	Protocol Select	Front panel switch control, low to enable.
8	O	Ground	Data ground.
9	I	RxD2	RS232 Altitude data input to ATS-400.

Connector P2 IBM PC Port

Front panel connector DE-9S, mating connector DE-9P.

Pin	I/O	Connection	Function
1	O	Ground	Data ground.
2	I	RxD	RS232 Data input to IBM PC.
3	O	TxD	RS232 Data output from IBM PC.
4	X	N/C	No connection.
5	O	Ground	Data ground
6	X	N/C	No connection.
7	X	N/C	No connection.
8	X	N/C	No connection.
9	X	N/C	No connection.

Section 4.0 Power Connections

The ATS-400 may be powered via a single supply or via a dual supply, which will allow monitoring of the altitude reporting device power consumption.

Figure 3

AIRCRAFT POWER SUPPLY CONNECTION SINGLE SUPPLY OPTION

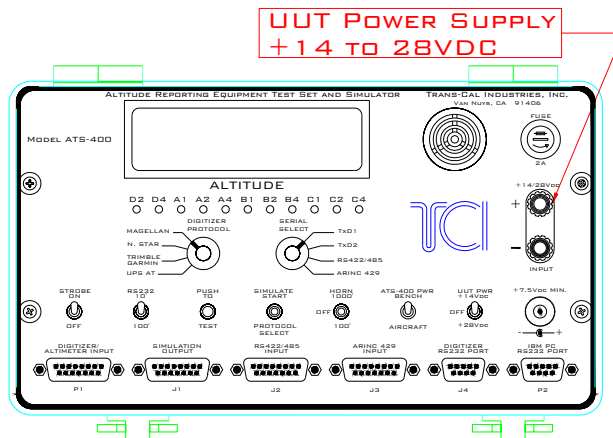

BENCH POWER SUPPLY CONNECTION DUAL SUPPLY OPTION

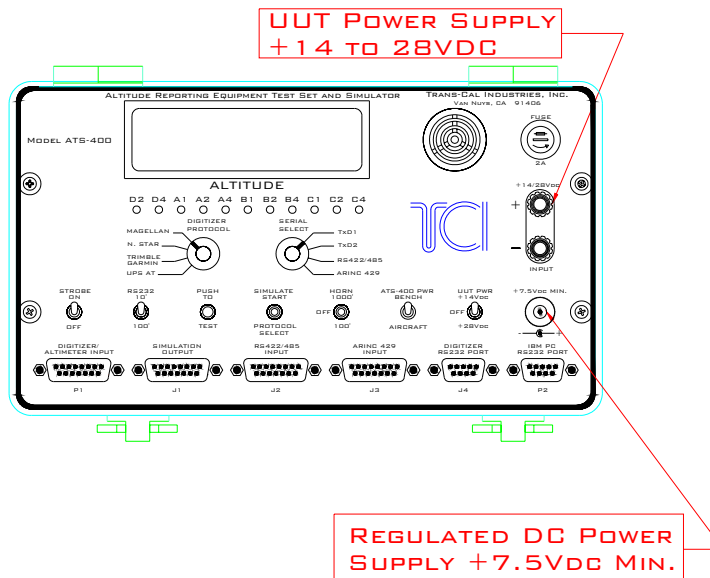

Section 5.0 Front Panel Switch Functions

Strobe On-Off Toggle Switch	
On	Applies ground to pin 6 of front panel connector P1. ICAO altitude data enable.
Off	Open circuit to pin 6 of front panel connector P1. ICAO altitude data disable.

RS232 10'-100' Toggle Switch	
10'	Applies ground to pin 2 of front panel connectors J2, J3, J4. Serial altitude data 10-foot resolution enable output to digitizer.
100'	Open circuit to pin 2 of front panel connectors J2, J3, J4. Serial altitude data 100-foot resolution enable output to digitizer.

Push-To-Test Pushbutton	
ON	Test sequence of LED and alphanumeric display.

Simulate/Protocol Toggle Switch	
Simulate Start	Starts altitude encoder output simulation, See section 8.0.
Off	Center off position.
Protocol Select	Scrolls through ATS-400 serial data simulation output protocols see section 8.0.

Horn 1000'/100' Toggle Switch	
1000'	Horn sounds at 1000' ICAO altitude code transitions.
OFF	Horn off.
100'	Horn sounds at 100' ICAO altitude code transitions.

Aircraft/Bench Toggle Switch	
Bench	ATS-400 Vdc power is isolated from Input Vdc for (UUT) unit under test. ATS-400 power provided through 2.1mm front panel jack.
Aircraft	ATS-400 Vdc power is coupled to 5-Way binding post +14 to 28Vdc for (UUT) unit under test.

UUT Power Toggle Switch	
+14 Vdc	ATS-400 Power on. Input Vdc from binding post is directed to pin 14 of front panel connectors P1 and J3.
Off	Center off position.
+28Vdc	ATS-400 Power on. Input Vdc from binding post is directed to pin 8 of front panel connectors P1 and J3.

Section 6.0 Front Panel Rotary Switch Functions

Position	Digitizer Protocol Rotary Switch
UPS AT	Protocol Select pins on connectors J2, J3, J4 are open.
Trimble/Garmin	Protocol Select pin 7 on connector J4, Pin 10 on connectors J2 and J3 are grounded.
N. Star	Protocol Select pin 6 on connector J4, Pin 9 on connectors J2 and J3 are grounded.
Magellan	Protocol Select pins 6 & 7 on connector J4, Pins 9 & 10 on connectors J2 and J3 are grounded.

Position	Serial Select Rotary Switch
TxD1	Connects Pin 4 of J2, J3 and J4 to the ATS-400 processor serial data input.
TxD2	Connects pin 9 of J4, and Pin 12 of J2 to the ATS-400 processor serial data input.
RS422/485	Connects pins 11 & 12 of J2 to the ATS-400 processor serial data input.
ARINC 429	Connects pins 11 & 12 of J3 to the ATS-400 processor serial data input.

Section 7.0 Serial Interface Specifications

The following section details the serial data message formats and protocols currently accepted by the ATS-400. There is no accepted standard protocol for RS232 altitude data transmission. As a result, many avionics manufacturers developed unique protocols. Many of these different protocols are accepted by the ATS-400 and are detailed in this section. More formats and protocols may be added in the future as required.

7.1 General Characteristics of Serial Data Inputs

RS232 is an “unbalanced” serial communication format conforming to the EIA/TIA RS-232C standard. Logic levels typically seen on RS232 data lines are +9 (logic 0) and -9Vdc (logic 1). These voltages may drop to ± 5 Vdc at full load impedance of 3K ohms. All voltages are measured between signal and ground. Altitude reporting devices typically utilize asynchronous transmission in a simplex or talk only system. Baud rates, currently utilized by altitude reporting devices, range from 1200 to 9600 bps. The RS-232 standard specifies one transmitter and one receiver per RS232 port.

RS422 is a “balanced” two wire serial communication format conforming to the EIA/TIA RS-422 standard. Logic levels seen on RS422 data lines may range from +2 to +5Vdc (logic 0) and -2 to -5Vdc (logic 1). Driver load impedance is typically 100 ohms. All voltages are measured as signal A with respect to signal B. Altitude reporting devices typically utilize asynchronous transmission in a simplex or talk only system. Baud rates range from 1200 to 9600 bps. The RS-422 standard specifies one transmitter and seven receivers per two-wire data bus.

RS485 is a “balanced” two wire serial communication format conforming to the EIA/TIA RS-485 standard. Logic levels seen on RS485 data lines may range from +1.5 to +5Vdc (logic 0) and -1.5 to -5Vdc (logic 1). Driver load impedance is typically 54 ohms. All voltages are measured as signal A with respect to signal B. Altitude reporting devices typically utilize asynchronous transmission in a simplex or talk only system. Baud rates, currently utilized by altitude reporting devices, range from 1200 to 9600 bps. The RS-485 standard specifies one transmitter and thirty-two receivers per two-wire data bus.

ARINC 429 is a “balanced” two wire serial communication format conforming to the ARINC 429 Mark 33 Digital Information Transfer Standard. Logic levels typically seen on ARINC 429 data lines are $\pm 5\text{Vdc}$, 0Vdc (null), $\pm 10\text{Vdc}$. All voltages are measured as signal A with respect to signal B. ARINC 429 devices utilize unidirectional, bipolar return to zero transmission in a simplex or talk only system. Currently the ATS-400 receives only label 203 for pressure altitude at low speed (12.5kbps). The ARINC 429 standard specifies one transmitter and twenty receivers per two-wire data bus.

7.2 ARINC 429 Label 203 Protocol

Electrical Format:

Per ARINC 429 Standard Mark 33 Digital Information Transfer Standard (DITS)

Transmission Method:	Unidirectional, bipolar return to zero.
Transmission Rate:	Low Speed 12.5kbps
Word Size:	32 Bit
Update Rate:	2/second
Transmit Interval:	50ms

Altitude Data Message:

BIT	FUNCTION	CODING		NOTES
1	Label 1 st Digit	1	2	
2	Label 1 st Digit	0		
3	Label 2 nd Digit	0	0	
4	Label 2 nd Digit	0		
5	Label 2 nd Digit	0		
6	Label 3 rd Digit	0	3	
7	Label 3 rd Digit	1		
8	Label 3 rd Digit	1		
9	Pad			
10	Pad			
11	Altitude Resolution	0 = 1 feet 1 = 100 feet		
12	Altitude	1 ft.		Altitude represented in two's complement fractional binary notation. (LSB = 1 ft.) (Range = 131,072 ft.)
13	Altitude	2 ft.		
14	Altitude	4 ft.		
15	Altitude	8 ft.		
16	Altitude	16 ft.		
17	Altitude	32 ft.		
18	Altitude	64 ft.		
19	Altitude	128 ft.		
20	Altitude	256 ft.		
21	Altitude	512 ft.		
22	Altitude	1024 ft.		
23	Altitude	2048 ft.		
24	Altitude	4096 ft.		
25	Altitude	8192 ft.		
26	Altitude	16384 ft.		
27	Altitude	32768 ft.		
28	Altitude	65536 ft.		
29		Sign		
30	SSM	(MSB)		Bit 30 & 31 SSM Definitions: 0 0 Failure 0 1 No Computed Data 0 0 Functional Test 1 1 Normal Operation
31	SSM	(LSB)		
32	Parity	(Odd)		

Message Display Example:

ARINC429 LBL203 +001611

7.3 ARNAV PROTOCOL

Electrical Format:

RS232C transmit only (half duplex) with the following characteristics:

Baud Rate:	9600 bps
# Data Bits:	8
Parity:	None
Stop Bits:	1
Output Rate:	1/Sec.
Code:	ASCII

Altitude Data Message:

Altitude Data Resolution: 1 Meter.

22 Byte Message:

Byte:	1	2	3	4	5	6	7	8	9	10	11	12	13	14	15	16	17	18	19	20	21	22
Message:	\$	P	A	S	H	S	,	A	L	T	,	s	d	d	d	d	d	*	cc	cc	←	↓

Where:

1. Byte 1: \$ = NMEA Message Start Character.
2. Byte 2 to 6: PASHS = ARNAV Proprietary Message Name.
3. Byte 7: , = Comma Separator.
4. Byte 8 to 10: ALT = Proprietary Message ID.
5. Byte 11: , = Comma Separator.
6. Byte 12: s = Sign (+ or -).
7. Byte 13 to 17: d = Altitude in Meters.
8. Byte 18: * = Checksum Delimiter Character.
9. Byte 19 to 20: cc = Check Sum.
10. Byte 21: ← = Carriage Return.
11. Byte 22: ↓ = Linefeed

Message Display Example:

\$PASHS,ALT,+00033*1B←↓

7.4 MAGELLAN PROTOCOL

Electrical Interface:

RS232C with the following characteristics:

Baud Rate:	1200 bps
# Data Bits:	7
Parity:	Even
Stop Bits:	1
Output Rate:	1/Sec.
Code:	ASCII

Altitude Data Message:

Altitude Data Resolution: 100 ft. or 10 ft.

17 Byte Message:

Byte:	1	2	3	4	5	6	7	8	9	10	11	12	13	14	15	16	17
Message:	\$	M	G	L	s	d	d	d	d	d	T	s	t	t	cc	cc	←

Where:

1. Byte 1: \$ = ASCII "\$"
2. Byte 2: M = ASCII "M"
3. Byte 3: G = ASCII "G"
4. Byte 4: L = ASCII "L"
5. Byte 5: s = Sign (+ or -).
6. Byte 6 to 10: d = Altitude in feet, right justified, with leading zeros.
7. Byte 11: T = ASCII "T"
8. Byte 12: s = Sign (+ or -).
9. Byte 13 to 14: t = Sensor temperature in °C.
10. Byte 15 to 16: cc = Check Sum
11. Byte 17: ← = Carriage Return.

Message Display Example:

\$MGL+00050T+25D6←

7.5 NORTHSTAR PROTOCOL

Electrical Format:

RS232C transmit only (half duplex) with the following characteristics:

Baud Rate:	2400 bps
# Data Bits:	8
Parity:	None
Stop Bits:	1
Output Rate:	1/Sec.
Code:	ASCII

Altitude Data Message:

Altitude Data Resolution: 100 ft. or 10 ft.

10 Byte Message:

Byte:	1	2	3	4	5	6	7	8	9	10
Message:	A	L	T	<Space>	-/d	d	d	d	d	←

Where:

1. Byte 1: A = ASCII "A"
2. Byte 2: L = ASCII "L"
3. Byte 3: T = ASCII "T"
4. Byte 4: Space = ASCII Space
5. Byte 5: -/d = Negative Sign or altitude data.
6. Byte 6 to 9: d = Altitude in feet, right justified, with leading zeros.
7. Byte 10: ← = Carriage Return

Message Display Example:

ALT 00050←←

Error/Status Messages:

The following error/status codes replace the altitude data as follows:

-02500 Encoder disabled.

7.6 SHADIN PROTOCOL

Electrical Interface:

RS232C transmit only (half duplex) with the following characteristics:

Baud Rate:	9600 bps
# Data Bits:	8
Parity:	None
Stop Bits:	1
Output Rate:	1/Sec.
Code:	ASCII

Altitude Data Message:

Altitude Data Resolution 1 ft.

17 Byte Message:

Byte:	1	2	3	4	5	6	7	8	9	10	11	12	13	14	15	16	17
Message:	R	M	S	<Space>	s	d	d	d	d	d	T	s	t	t	cc	cc	←

Where:

- | | | | | |
|-----|----------------|-------|---|--|
| 1. | Byte 1: | R | = | ASCII "R" |
| 2. | Byte 2: | M | = | ASCII "M" |
| 3. | Byte 3: | S | = | ASCII "S" |
| 4. | Byte 4: | Space | = | ASCII Space |
| 5. | Byte 5: | s | = | Sign (+ or -). |
| 6. | Byte 6 to 10: | d | = | Altitude in feet, right justified, with leading zeros. |
| 7. | Byte 11: | T | = | ASCII "T" |
| 8. | Byte 12: | s | = | Sign (+ or -). |
| 9. | Byte 13 to 14: | t | = | Sensor temperature in °C. |
| 10. | Byte 15 to 16: | cc | = | Check Sum |
| 11. | Byte 17: | ← | = | Carriage Return. |

Message Display Example:

RMS +00015T+551C←

7.7 TRIMBLE/GARMIN PROTOCOL

Electrical Format:

RS232C transmit only (half duplex) with the following characteristics:

Baud Rate:	9600 bps
# Data Bits:	8
Parity:	None
Stop Bits:	1
Output Rate:	1/Sec.
Code:	ASCII

Altitude Data Message:

Altitude Data Resolution: 100 ft. or 10 ft.

10 Byte Message:

Byte:	1	2	3	4	5	6	7	8	9	10
Message:	A	L	T	<Space>	-/d	d	d	d	d	←

Where:

1. Byte 1: A = ASCII "A"
2. Byte 2: L = ASCII "L"
3. Byte 3: T = ASCII "T"
4. Byte 4: Space = ASCII Space
5. Byte 5: -/d = Negative Sign or altitude data.
6. Byte 6 to 9: d = Altitude in feet, right justified, with leading zeros.
7. Byte 10: ← = Carriage Return

Message Display Example:

ALT 00050←

Error/Status Messages:

The following error/status codes replace the altitude data as follows:

-99900 Encoder disabled.

7.8 UPS AT PROTOCOL

Electrical Format:

RS232C transmit only (half duplex) with the following characteristics:

Baud Rate:	1200 bps
# Data Bits:	8
Parity:	None
Stop Bits:	1
Output Rate:	1/Sec.
Code:	ASCII

Altitude Data Message:

Altitude Data Resolution: 100 ft. or 10 ft.

17 Byte Message:

Byte:	1	2	3	4	5	6	7	8	9	10	11	12	13	14	15	16	17
Message:	#	A	L	<Space>	s	d	d	d	d	d	T	s	t	t	cc	cc	←

Where:

1. Byte 1: # = ASCII “#”
2. Byte 2: A = ASCII “A”
3. Byte 3: L = ASCII “L”
4. Byte 4: Space = ASCII Space
5. Byte 5: s = Sign (+ or -).
6. Byte 6 to 10: d = Altitude in feet, right justified, with leading zeros.
7. Byte 11: T = ASCII “T”
8. Byte 12: s = Sign (+ or -).
9. Byte 13 to 14: t = Sensor temperature in °C.
10. Byte 15 to 16: cc = Check Sum
11. Byte 17: ← = Carriage Return.

Message Display Example:

#AL +00050T+25D6←

Error/Status Messages:

The following error/status codes replace the altitude data as follows:

- 09980 Encoder heater not ready.
- 09981 Possible encoder hardware problem.
- 09982 Altitude out of range.

7.9 UPS AT LORAN 618 PROTOCOL

Electrical Format:

RS232C transmit only (half duplex) with the following characteristics:

Baud Rate:	1200 bps
# Data Bits:	7
Parity:	Odd
Stop Bits:	1
Output Rate:	1/Sec.
Code:	ASCII

Altitude Data Message:

Altitude Data Resolution: 100 ft. or 10 ft.

17 Byte Message:

Byte:	1	2	3	4	5	6	7	8	9	10	11	12	13	14	15	16	17
Message:	#	A	L	<Space>	s	d	d	d	d	d	T	s	t	t	cc	cc	←

Where:

1. Byte 1: # = ASCII “#”
2. Byte 2: A = ASCII “A”
3. Byte 3: L = ASCII “L”
4. Byte 4: Space = ASCII Space
5. Byte 5: s = Sign (+ or -).
6. Byte 6 to 10: d = Altitude in feet, right justified, with leading zeros.
7. Byte 11: T = ASCII “T”
8. Byte 12: s = Sign (+ or -).
9. Byte 13 to 14: t = Sensor temperature in °C.
10. Byte 15 to 16: cc = Check Sum
11. Byte 17: ← = Carriage Return.

Message Display Example:

#AL +00050T+25D6←←

Error/Status Messages:

The following error/status codes replace the altitude data as follows:

- 09980 Encoder heater not ready.
- 09981 Possible encoder hardware problem.
- 09982 Altitude out of range.

7.10 Serial Data Matrix

Protocol	Baud Rate	Data Bits	Parity	Stop Bits	Flow Cntl.	Byte 1	Byte 2	Byte 3	Byte 4	Byte 5	Byte 6	Byte 7	Byte 8	Byte 9	Byte 10	Byte 11	Byte 12	Byte 13	Byte 14	Byte 15	Byte 16	Byte 17	Byte 18	Byte 19	Byte 20	Byte 21	Byte 22
Trimble/ Garmin/ Icarus	9600	8	N	1	N	A	L	T	S p a c e	d	d	d	d	d	←	/	/	/	/	/	/	/	/	/	/	/	/
Northstar	2400	8	N	1	N	A	L	T	S p a c e	d	d	d	d	d	←	/	/	/	/	/	/	/	/	/	/	/	/
UPS AT	1200	8	N	1	N	#	A	L	S p a c e	±	d	d	d	d	d	T	±	T e m p ° C	T e m p ° C	C h k. s u m	C h k. s u m	←	/	/	/	/	
UPS AT 618 LORAN	1200	7	O	1	N	#	A	L	S p a c e	±	d	d	d	d	d	T	±	T e m p ° C	T e m p ° C	C h k. s u m	C h k. s u m	←	/	/	/	/	
Magellan	1200	7	E	1	N	\$	M	G	L	±	d	d	d	d	d	T	±	T e m p ° C	T e m p ° C	C h k. s u m	C h k. s u m	←	/	/	/	/	
Shadin	9600	8	N	1	N	R	M	S	S p a c e	±	d	d	d	d	d	T	±	T e m p ° C	T e m p ° C	C h k. s u m	C h k. s u m	←	/	/	/	/	
ARNAV	9600	8	N	1	N	\$	P	A	S	H	S	,	A	L	T	,	±	d	d	d	d	d	*	C h k. s u m	C h k. s u m	←	↓

Section 8.0 Simulation Mode

The ATS-400 will simulate the output of altitude reporting devices in both ICAO parallel and serial RS232 formats. This function is controlled by the SIMULATE START/PROTOCOL SELECT toggle switch. The ICAO parallel code is provided on connector J1 labeled SIMULATION OUTPUT. The RS232 data is provided on pin 13 of connector J2, labeled RS422/485.

Parallel ICAO Simulation:

1. Prior to entering the simulate mode, disconnect any digitizer which may input data to the ATS-400.
2. Connect a transponder, GPS, MFD Auto Pilot or other device to the ICAO parallel simulation output connector J1. Following is a wiring example using the UPS AT SL-20 transponder.
3. Apply power to the transponder and switch the ATS-400 UUT power switch to the on position.
4. Switch the transponder to ALT mode.
5. Push the Simulate Start switch up once. The ATS-400 will begin transmitting the ICAO altitude code at a rate of 6000 feet per minute beginning at -1100 feet. To hold an altitude, push the Simulate Start switch up once. To increase the rate of climb to 30,000 feet per minute push the Simulate Start button twice. To descend, push the Simulate Start button down.

Wiring connection using serial data (RS232) interface. Note! UPS AT Protocol must be selected with protocol toggle switch on the ATS-400.

ATS-400 Connector J2		UPS AT SL70 Rear Connector
Pin	Function	Pin
13	TxD	4
1	Serial Ground	3

ATS-400 Conn. J1		UPS AT SL-20 Transponder Rear Connector
Pin	Function	Pin
1	D4	35
2	A1	13
3	A2	31
4	A4	12
5	B1	33
6	Signal Common Connect to ground to enable.	No connection.
7	D2	No connection.
No connection.	Transponder Vdc input.	1
9	B2	14
10	B4	32
11	C1	16
12	C4	15
13	C2	34
No connection.	Transponder Vdc input.	1
15	Ground	2

Wiring Harness Diagram for the ATS-400 Test Set

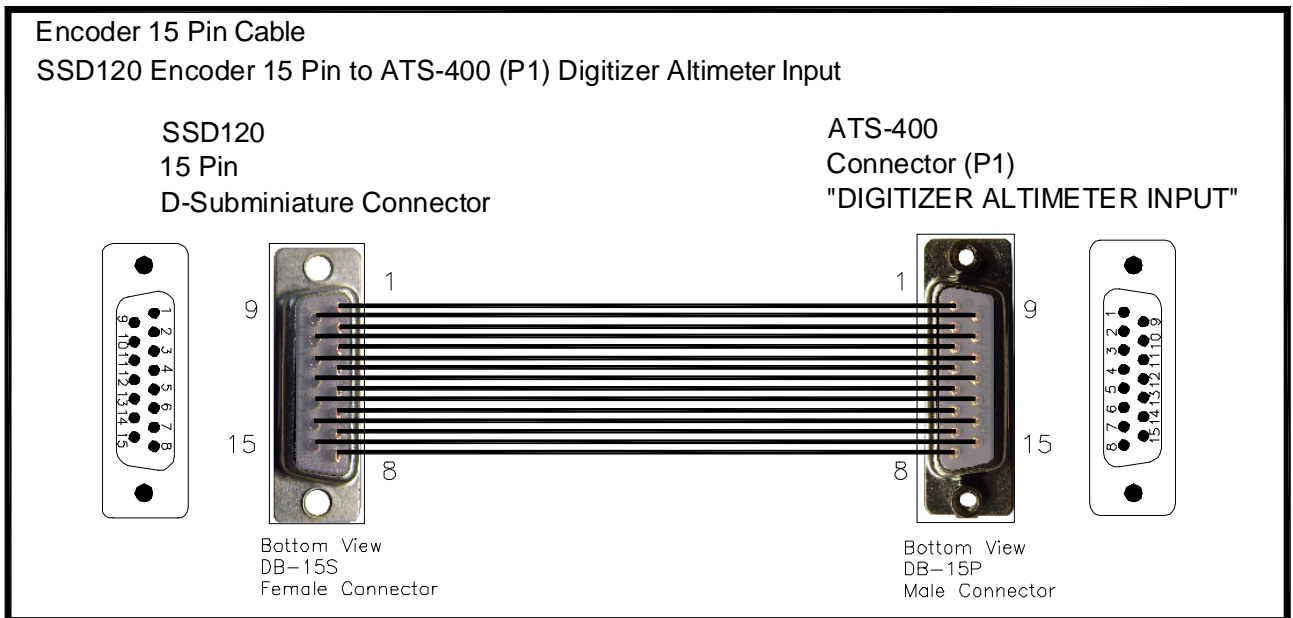
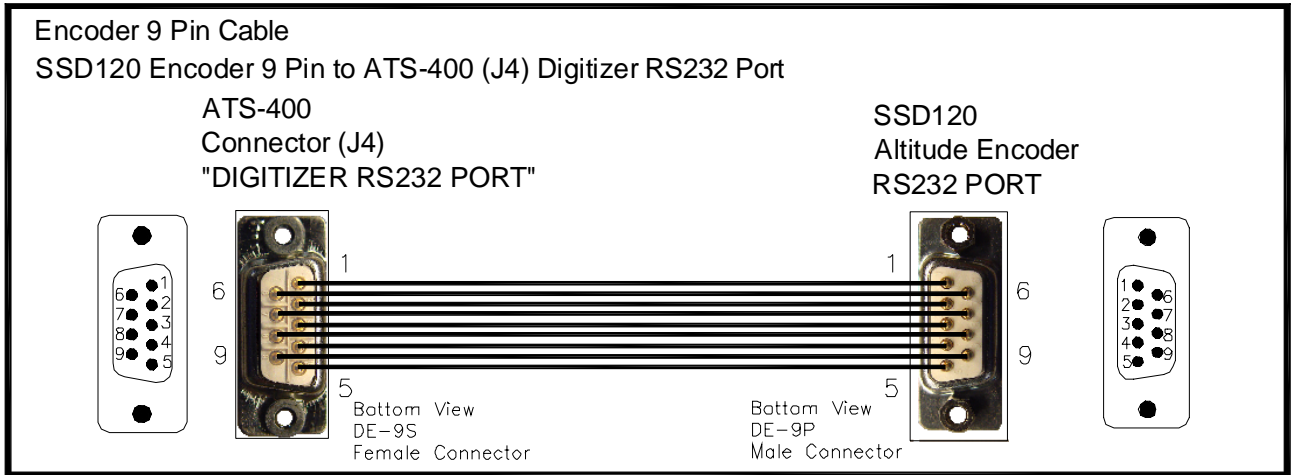
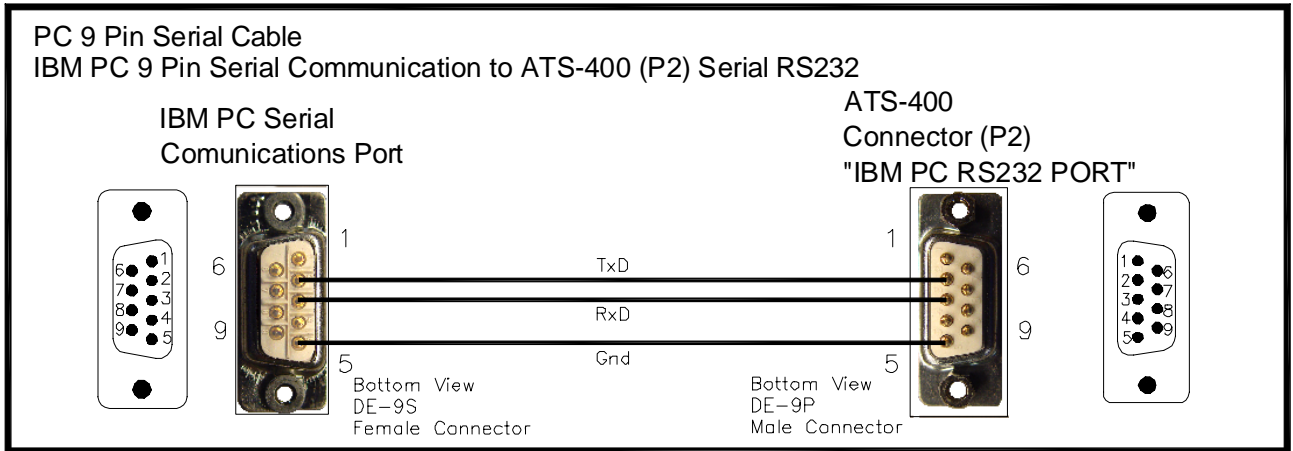

WARRANTY REGISTRATION

Trans-Cal Industries warrants each Model ATS-400 Test Set & Simulator to be free of defects in workmanship and materials for a period of 18 months after purchase. This warranty applies to the original purchaser of the instrument.

Trans-Cal's obligation under this warranty is limited to repairing or replacing any unit returned to Trans-Cal during the life of this warranty provided:

- (1) The defective unit is returned to us, **transportation pre-paid**.
- (2) Prior approval is obtained from Trans-Cal.
- (3) The unit has not been damaged by misuse, neglect, improper operation, accident or alteration.

Trans-Cal **DOES NOT** reimburse labor costs on warranty repairs. Trans-Cal Industries will be the sole judge as to the cause of the malfunction and wherein the responsibility lies. No other obligation or liability is expressed or implied.

For the above warranty to become effective, the attached registration card **must** be completed and returned to Trans-Cal Industries, properly filled out and signed by the dealer selling or installing this equipment.

Mail to: Trans-Cal Ind., Inc., 16141 Cohasset St., Van Nuys, CA 91406

----- cut here -----

MODEL: ATS-400

SERIAL NO: _____

OWNER: _____

ADDRESS: _____

CITY: _____ STATE: _____ ZIP: _____

DEALER: _____

SIGNED: _____

PRINT NAME: _____

©2004 Trans-Cal Industries, Inc.
16141 Cohasset Street
Van Nuys, CA 91406-2908
(818)787-1221 * (800)423-2913 * (818)787-8916FAX
www.trans-cal.com