

AVAILABLE SUMMER 2017

New for 2017
Trans-Cal Industries, Inc.
Model SSD120-(XX)C & SSD120-(XX)C-RS232
Altitude Digitizer

The Smallest, Lightest and Lowest Power Consumption
Altitude Digitizer on the Market!

The SSD120-(XX)C & SSD120-(XX)C-RS232 are designed to provide a rugged and reliable altitude digitizer for applications where size, weight and economy are critical. Incorporating one ICAO gray code port SSD120-(XX)C, and adding two RS232 serial altitude data outputs on the SSD120-(XX)C-RS232, these encoders are a simple and robust addition to any avionics installation requiring accurate pressure altitude information for multiple aircraft systems.

SSD120-(XX)C & SSD120-(XX)C-RS232 features:

- 1/8-27NPT Static Port Inlet
- One ICAO pressure altitude gray code output
- Two RS232 serial altitude data outputs (SSD120-(XX)C-RS232 Only)
- Operating Temperature Range -20°C to +70°C
- Operating Voltage +10 to +33Vdc
- Operating Current +12Vdc @220mA / +28Vdc @270mA
- Operating Pressure Altitude Range -1000 to +30,000 and +35,000 feet
- FAA TSO-C88a and ETSO-C88a Approved
- Tested and conforming to MIL-STD-704E and RTCA DO-160E
- Power and data I/O lines provided on industry standard D-Subminiature Connector
- Weight 4.3 oz.
- 42 Month Warranty
- Calculated MTBF in excess of 8 years!
- Installation Hardware Included:
 - Quick Release Mounting Tray
 - Mating Electrical Connector and Back Shell
 - 1/8-27NPT to Tube Fitting and Plug
 - Installation Manual

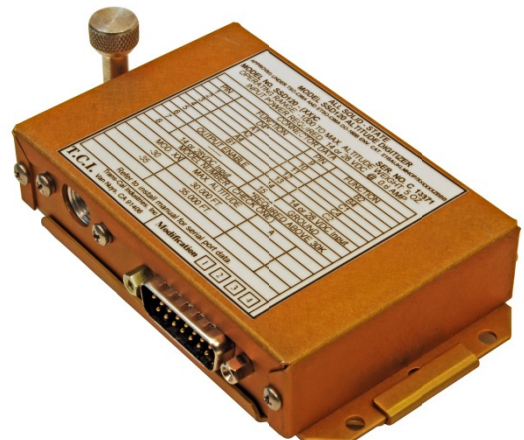

Trans-Cal Industries, Inc.
16141 Cohasset Street
Van Nuys, CA 91406

THIS DOCUMENT CONTAINS PROPRIETARY INFORMATION OF TRANS-CAL INDUSTRIES, INC. ANY REPRODUCTION, USE OR DISCLOSURE OF THIS DOCUMENT WITHOUT THE WRITTEN PERMISSION OF TRANS-CAL INDUSTRIES, INC. IS EXPRESSLY PROHIBITED.

REVISION HISTORY			
ECO	REV	DESCRIPTION	DATE
N/C	A	PRODUCTION RELEASE	06/23/2016
			APPROVED J. FERRERO

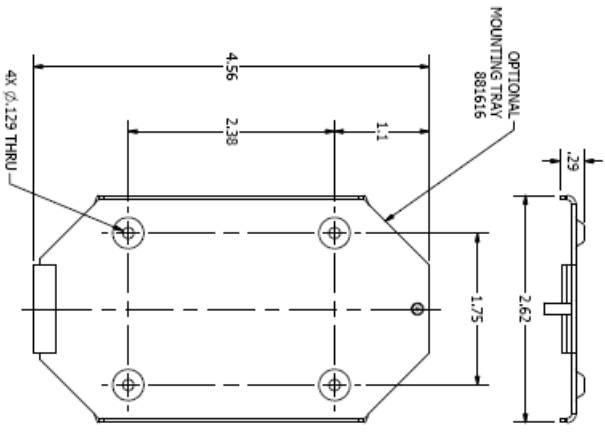
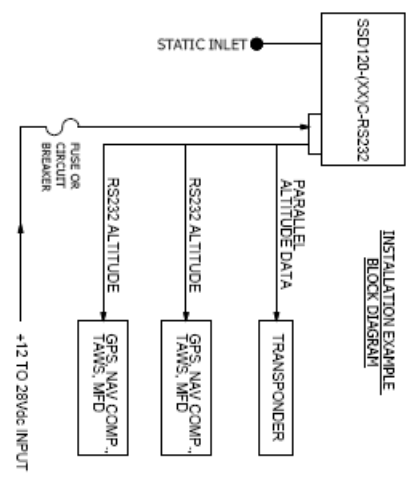
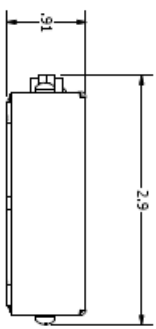
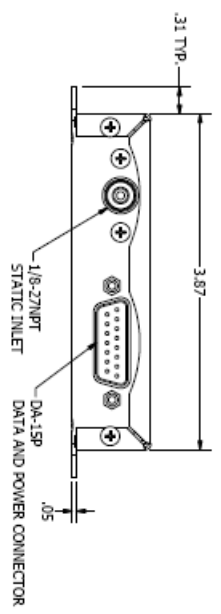
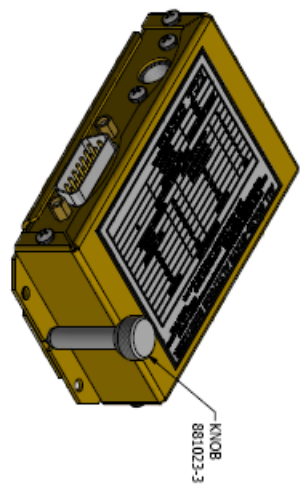
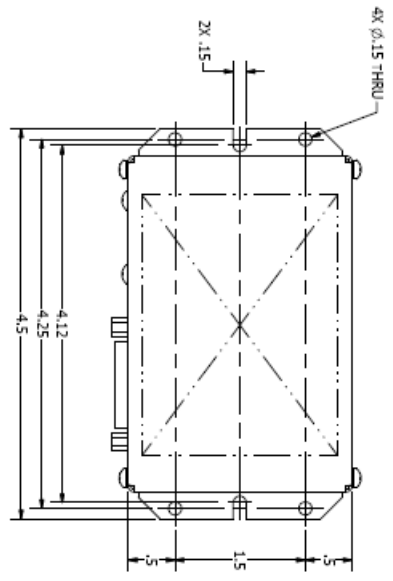

MODEL NUMBER (XX)C DESIGNATIONS	
MODEL NO.	OPERATING RANGE
SSD120-30C-RS232	-1000 TO +90,000 FT.
SSD120-35C-RS232	-1000 TO +35,000 FT.

DA-15P D-SUB CONNECTOR	
PIN	FUNCTION
1	D+
2	D-
3	A1
4	A2
5	A4
6	B1
7	OUTPUT ENABLE
8	+14 TO 28VDC INPUT
9	B2
10	B4
11	C1
12	C4
13	C2
14	TxD1
15	GROUND

MTL FINISH
MODEL SSDD120-(XX)C-RS232
TOP ASSY: 881618

DRAWN
H. Smith
3/16/2016
CHECKED
M. Remenh
3/16/2016
QA
J. Ferrero
3/17/2016
ENG
C. Herraiz
3/16/2016
APPROVED
J. Ferrero
3/16/2016

Trans-Cal Industries, Inc.
Van Nuys, CA 91406

OUTLINE DRAWING SSDD120-(XX)C-RS232

TOLERANCES UNLESS OTHERWISE NOTED:
Decimals: Angle ±.1°
.063 ±.010
.0001 ±.005
THIRD ANGLE PROJECTION

SIZE
C
SCALE 1:1
UNITS INCH

DO NOT SCALE
DRAWING
SSDD120-(XX)C-RS232
DWG NO.
REV
A

1. APPROVED UNDER FAA TSO-C88A AND ETSO-C88A.