

**Trans-Cal Industries, Inc.**

Model SSD120-(XX)A-RS1  
&  
Model SSD120-(XX)AE-RS1

All Solid-State  
Altitude Encoder/Digitizer

Owner/Installation Manual

T.S.O. C88a Approved

For Shadin AMS 2000

TCI CAL P22

Trans-Cal Industries, Inc.  
Van Nuys Airport  
16141 Cohasset Street  
Van Nuys, CA 91406-2908  
(818) 787-1221 (800) 423-2913 fax (818) 787-8916  
[www.trans-cal.com](http://www.trans-cal.com)

10 August 2006

Document Number: 930007

Revision: D

This document may not be reproduced, transmitted, or copied in any form without the prior written consent of Trans-Cal Industries, Inc. The data contained herein is subject to change without notice.

Please Note:

It is the responsibility of the installer of this equipment, within a specific type or class of aircraft, to determine that the aircraft operating conditions are within TSO standards.

© 2003 by Trans-Cal Industries, Inc.  
16141 Cohasset Street  
Van Nuys, CA 91406

818/787-1221  
800/423-2913  
FAX 818/787-8916  
[www.trans-cal.com](http://www.trans-cal.com)

History of Revision

<u>Revision</u>	<u>Date</u>	<u>Description</u>
--	07/98	Production release.
A	10/99	Added SL70 transponder data.
B	01/00	Added +12V reference, note 2, page 1.
C	08/04	Updated Manual
D	08/06	Updated Manual changed warranty from 40 to 42 months

## Table of Contents

Abbreviations and Symbols .....	4
Section 1.0 Introduction .....	5
1.1 Scope .....	5
1.2 Equipment Description .....	5
1.3 General Specifications .....	5
1.3.1 Operating Altitude .....	6
1.3.2 Accuracy .....	6
1.3.3 Mechanical Characteristics .....	6
1.3.4 Environmental .....	6
1.3.5 Over Range .....	6
1.4 Parallel ICAO Altitude Data Port Specifications .....	7
1.5 Serial Altitude Data Port Specifications .....	7
1.6 Serial Port Altitude Data Resolution .....	8
1.7 Serial Communication Format .....	8
1.8 Serial Communication Protocol .....	9
Section 2.0 Operation .....	10
2.1 General .....	10
2.2 Operating Instructions .....	11
Section 3.0 Installation .....	11
3.1 Mechanical Installation .....	11
3.2 Electrical Installation .....	12
3.3 Serial Altitude Data Port Test Equipment .....	13
3.4 Parallel ICAO Altitude Data Port Test Equipment .....	13
Section 4.0 Calibration and Configuration .....	14
4.1 Calibration Overview .....	14
4.2 Required Equipment Span Adjust .....	15
4.3 Required Equipment Dynamic Calibration .....	15
4.4 Span Adjust Procedure .....	16
4.5 Hyper Terminal Set-Up on the IBM Compatible PC .....	17
4.6 Serial Port Software Configuration .....	18
4.7 Dynamic Calibration Adjustment Procedure .....	19
4.8 Configuration and Calibration Command List .....	22
4.9 Error Correction Table .....	23
Digitizer Interconnection Tables .....	24
GPS/MFD Connection Data .....	32
Temperature vs. Warm-up Time Figure 3 .....	36
Shadin Installation Wiring Diagram .....	37
Outline Drawing SSD120-XXX-RS1 .....	38
Wiring Harness Diagram P/N: 881404 .....	39
Span Adjust Block Diagram .....	40
NARCO Transponder Installations .....	41
WARRANTY REGISTRATION .....	43

## Abbreviations and Symbols

<b>A</b>	Amperes
<b>AC</b>	Advisory Circular
<b>ARINC</b>	Aeronautical Radio Incorporated
<b>ASCII</b>	American Standard for Coded Information Interchange
<b>ATCRBS</b>	Air Traffic Control Radar Beacon System
<b>bps</b>	Bits per second.
<b>C<sub>R</sub></b>	Carriage Return
<b>EEPROM</b>	Electrically Erasable Read Only Memory
<b>EIA</b>	Electronic Industries Association
<b>FAA</b>	Federal Aviation Administration
<b>FAR</b>	Federal Aviation Regulation
<b>ft.</b>	Distance in feet.
<b>GPS</b>	Global Positioning System
<b>Hz</b>	Hertz
<b>ICAO</b>	International Civil Aviation Organization
<b>I.F.F.</b>	Identification Friend or Foe
<b>In. Hg.</b>	Inches of Mercury
<b>Kbps</b>	Kilobits per Second
<b>KHz</b>	Kilohertz
<b>L<sub>F</sub></b>	Line Feed
<b>LSB</b>	Least Significant Bit
<b>mA</b>	Milliamperes
<b>max.</b>	Maximum
<b>MB</b>	Millibar
<b>MHz</b>	Megahertz
<b>MFD</b>	Multi-Function Display
<b>MSL</b>	Mean Sea Level
<b>min.</b>	Minimum
<b>ms</b>	Time in milliseconds.
<b>MSB</b>	Most Significant Bit
<b>NIST</b>	National Institute of Standards and Technology
<b>oz</b>	Ounce
<b>psi</b>	Pounds per Square Inch
<b>RAM</b>	Random Access Memory
<b>RS</b>	Recommended Standard
<b>RTCA</b>	RTCA Inc. (formerly Radio Technical Commission for Aeronautics.)
<b>SAE</b>	Society of Automotive Engineers
<b>sec.</b>	Time in seconds.
<b>SSR</b>	Secondary Surveillance Radar
<b>TCI</b>	Trans-Cal Industries, Inc.
<b>TIA</b>	Telecommunication Industries Association
<b>TSO</b>	Technical Standard Order
<b>Vdc</b>	Volts Direct Current
<b>VSI</b>	Vertical Speed Indicator
<b>Ω</b>	Electrical resistance measured in Ohms.
<b>°C</b>	Temperature in degrees centigrade.
<b>±</b>	Plus or minus.
<b>§</b>	Section

## Section 1.0 Introduction

### 1.1 Scope

This manual provides detailed installation, calibration and operating instructions for Trans-Cal Industries' Model SSD120-(XX)A-RS1 and SSD120-(XX)AE-RS1<sup>1</sup> series of altitude encoder/digitizer.

### 1.2 Equipment Description

Approved under F.A.A. TSO-C88a, the Model SSD120-(XX)A-RS1 and SSD120-(XX)AE-RS1 is an all solid-state electronic device which, when connected to an aircraft static and electrical system, converts pressure altitude information into parallel and serial digital data.

The parallel digital altitude data protocol is set forth in the ICAO International Standard for SSR Pressure Altitude Transmission. In accordance with U.S. National Standards for Common System Component Characteristics for the I.F.F. Mark X (SIF)/Air Traffic Control Radar Beacon System SIF/ATCRBS.

The serial altitude data is provided on (2) two asynchronous **RS232** output ports and one (1) **RS485** port. The serial data protocol is selectable and may be used to provide pressure altitude data to GPS or other on board navigation devices. Refer to **Table VII**, **Table VIII** and **§4.6** The **RS485** data will utilize the same data protocol and format as assigned to **TxD1**. The **TxD2** port will provide altitude data in a format compatible with the Shadin AMS2000 with a resolution of 1 foot.

### 1.3 General Specifications

Operating Voltage: Model SSD120-(XX)A-RS1 Model SSD120-(XX)AE-RS1 <sup>2</sup>	+12 to 30 Vdc +12 to 30 Vdc
Operating Current all models:	0.54 Amps at 14Vdc 0.60 Amps at 28Vdc
Operating Temperature: Model SSD120-(XX)A-RS1 Model SSD120-(XX)AE-RS1	-20° to +70°C -55° to +70°C
Storage Temperature (non-operating) all models:	-65° to +85°C.
Warm-up time:	See Figure 3.
Weight:	10 oz.

<sup>1</sup> SSD120-(XX)AE-RS1 Extended operating temperature range: -55° to +70°C.

<sup>2</sup> Longer warm-up times will be experienced when operated at +12 VDC.

## **1.3 General Specifications(continued)**

### **1.3.1 Operating Altitude**

Model	Operating Altitude
SSD120-30A()-RS1	-1000 to +30,000 feet.
SSD120-35A()-RS1	-1000 to +35,000 feet.
SSD120-42A()-RS1	-1000 to +42,000 feet.

### **1.3.2 Accuracy**

Digitizer accuracy is  $\pm 50$  feet from -1000 to +30,000 feet, and  $\pm 75$  feet from 30,100 to +42,000 feet, when measured from the altitude transition points of the ICAO code and referenced to 29.92 In. Hg. (1013 MB.) See **Figure 1** and **§4.0**.

### **1.3.3 Mechanical Characteristics**

Model Number	Dimensions	Weight
Model SSD120-30A()-RS1	<i>See Outline Drawing</i>	10 oz.
Model SSD120-35A()-RS1	<i>See Outline Drawing</i>	10 oz.
Model SSD120-42A()-RS1	<i>See Outline Drawing</i>	10 oz.

### **1.3.4 Environmental**

All model SSD120-(XX)A()-RS1 digitizers have been designed and tested to meet the requirements of TSO-C88a, in accordance with RTCA Document DO160b, dated July 1984 (specifics provided upon request.) Environmental category: E1BA/JKLMNOPXXXXXXXXZBBBBBB.

### **1.3.5 Over Range**

The SSD120-(XX)A()-RS1 series of altitude digitizers will not be damaged when operated beyond their specified maximum altitude up to 100,000 feet MSL, (0.1581psi) or over pressured to -5721 feet (18psi) maximum.

## **1.4 Parallel ICAO Altitude Data Port Specifications**

Code Format: In accordance with U.S. National Standard for Common System Component Characteristics for the IFF Mark X (SIF) Air Traffic Control Radar Beacon System, SIF/ATCRBS.

Driver Description: The parallel altitude data output is provided by the “uncommitted” collectors of a transistor array and must be “pulled-up” through a resistive load by the transponder.

Pull-Up Voltage: +3 to 40Vdc.

Maximum Sink Current: 50 mA.

Maximum Cable Length: 4000 ft. (1219 meters)

Input Signal Requirement: Pin 6 (strobe or signal common) must be either grounded or connected to the transponder.

## **1.5 Serial Altitude Data Port Specifications**

### **RS232 Ports**

Electrical Format: Conforming to the TIA/EIA RS-232C standard.

Logic Levels: “0”, +9 Vdc. Logic “1”, -9 Vdc.

Driver Output Maximum Voltage:  $\pm 25$  Vdc.

Driver Load Impedance: 3K $\Omega$  typ.

The TIA/EIA RS232E standard recommends one receiver per serial port.

Maximum Cable Length: 50 Feet. (15.24 meters)

Code Format: ASCII

Communication System: Simplex

Transmission Method: Asynchronous. (Talk only.)

Transmission Rate: Selectable, 1200 bps to 9600 bps.

Update Rate: 1/sec.

## RS485 Port

Electrical Format: conforming to the TIA/EIA RS485A and the RS422 standard.

Logic Levels:

<u>Signal State</u>	<u>Threshold Voltages</u> (Signal A with respect to signal B)
0	+1.5 to +6 VDC (Transmitter)
1	-1.5 to -6 VDC (Transmitter)

Note: Some RS485 equipment use “+” and “-” connection descriptors. The “-” corresponds to “A” and the “+” corresponds to “B”.

Driver output maximum voltage: -7 to +12 VDC

Driver load impedance: 54Ω typ.

Maximum number of receivers on one line: 32.

Maximum cable length: 4000 feet. (1219.2 meters)

Code Format: ASCII

Communication System: Simplex (Talk Only).

Transmission Method: Asynchronous.

Transmission Rate: Selectable, 1200 bps to 9600 bps.

Update Rate: 10/sec. (While all ports are set to transmit at 9600bps.)

### **1.6 Serial Port Altitude Data Resolution**

The default resolution of the altitude digitizer serial data is 100 feet. To enable 10-foot resolution, connect pin 2 of the 9-pin D-Subminiature connector to ground (see **Table VII**.) The serial port resolution may also be configured via software, see §4.6. **TxD2** resolution is 1 foot and may not be altered.

### **1.7 Serial Communication Format**

Model SSD120-(XX)A( )-RS232 carries out serial communication asynchronously with the “Start/Stop” system. The specifics of the format, ie. the number of data bits, baud rate etc., is determined by the protocol selected.



## 1.8 Serial Communication Protocol

Refer to Table VII & VIII and §4.6)

Protocol is user selectable by grounding or leaving open pin 9 or pin 10 of the 15 pin DA-15S connector, or by selecting protocols via software see §4.6.

Leaving pin 9 and 10 of the 15 pin connector open results in a protocol compatible with UPS Aviation Technologies' (IIMorrow) Navigation devices. The Digitizer will send a seventeen byte message beginning with # AL, then a space followed by five altitude bytes; the letter "T" and the number "25"; two checksum bytes and a carriage return. (1200bps, 8 data bits, 1 stop bit, no parity.) Examples of serial messages for UPS AT (IIMorrow) devices.

Message	Definition
#AL +00800T+25D8 <sup>C<sub>R</sub></sup>	Altitude 800 feet

Grounding pin 10 of the 15 pin connector results in a protocol compatible with some navigation devices manufactured by Trimble and Garmin. The Digitizer will send a ten-byte message. The message begins with ALT followed by a space and five altitude bytes; concluding with a carriage return. (9600bps, 8 data bits, 1 stop bit, no parity.) Examples of serial messages for Trimble or Garmin devices:

Message	Definition
ALT 9990 <sup>C<sub>R</sub></sup>	Digitizer disabled.
ALT 10500 <sup>C<sub>R</sub></sup>	Altitude 10,500 feet

Grounding pin 9 of the 15 pin connector results in a protocol compatible with some navigation devices manufactured by Northstar and Garmin. The Digitizer will send a 10-byte message. The message begins with ALT followed by a space and five altitude bytes; concluding with a carriage return. (2400bps, 8 data bits, 1 stop bit, no parity.) Examples of serial messages for these devices:

Message	Definition
ALT 02500 <sup>C<sub>R</sub></sup>	Altitude 2500 feet.
ALT -2500 <sup>C<sub>R</sub></sup>	Digitizer disabled.

Grounding both pins 9 and 10 of the DA-15S connector results in a protocol compatible with some navigation devices manufactured by Magellan. The Digitizer sends a seventeen-byte message beginning with \$MGL, followed by a +/- sign and five altitude digits, then T+25, a checksum and concludes with a carriage return. (1200bps, 7 data bits, 1 stop bit, even parity.) Examples of serial messages for Magellan devices:

Message	Definition
\$MGL+02500T+25D6 <sup>C</sup> <sub>R</sub>	Altitude 2500 feet.

Leaving pins 9 and 10 of the DA-15S connector open, the ARNAV Systems protocol may be software selected see §4.6 for protocol selection details. Once selected, the Digitizer will send a 24-byte message. Beginning with a \$PASHS followed by a comma and ALT, then a +/- sign followed by five altitude digits (in meters,) then an asterisk and a checksum followed by a carriage return and a line feed. (9600bps, 8 data bits, 1 stop bit, no parity.) Example of an ARNAV serial altitude message:

Message	Definition
STX\$PASHS,ALT,+00033*1B <sup>C</sup> <sub>R</sub> <sup>L</sup> <sub>F</sub> ETX	Altitude 33 meters.

**Section 2.0 Operation**

**2.1 General**

The SSD-120(XX)A( )-RS1 series of altitude digitizer's are designed to be mounted within a pressurized or non-pressurized, but temperature controlled area within aircraft operating up to 42,000 feet MSL. Usually remotely located, the digitizer is fully automatic in operation. The parallel data output is controlled by the transponder while the serial altitude data is transmitted asynchronously. (Half duplex, talk only. Full duplex in calibration and configuration modes only.)

## **2.2 Operating Instructions**

### **Parallel Data:**

Place the transponder in mode “C”, altitude-reporting mode, and apply power to the transponder and to the digitizer. In some installations the digitizer will automatically be supplied power when the transponder is energized; in others, power to the digitizer may be through a separate circuit breaker. If power to the digitizer is provided directly from the aircraft’s avionics buss, follow the power-up procedures recommended by the transponder manufacturer. All parallel outputs will be pulled low for a self test at power up, then assume the value for the present input pressure. In some installations, the transponder controls the digitizer by enabling and disabling its outputs. In other installations, the digitizer’s output is not controlled by the transponder and is continuously enabled, (Digitizer DA-15P pin 6 is grounded.)

### **Serial Data**

The serial communication is fully automatic and transmission begins after the self-test is complete. Strobing the parallel data output of the digitizer will not affect the serial data transmission.

## **Section 3.0 Installation**

### **3.1 Mechanical Installation**

The SSD120-(XX)A( )-RS1 series of digitizer may be mounted in any attitude within the internal structure of the aircraft. DO NOT mount the digitizer in the direct air stream of either hot or cold air ducts. The mounting position should allow for a short static pressure line from the digitizer to the altimeter, access to the digitizer’s adjustments, and ample room for a service loop for the interconnecting cabling to the transponder.

Use #4-40 machine screws, sheet metal screws, or pop rivets to attach the digitizer or the mounting tray to the airframe. Secure mating connectors to the digitizer housing using the #4-40 screws provided. Refer to the outline drawing for mechanical dimensions and the installation block diagram.

## **3.2 Electrical Installation**

The digitizer is designed to operate with either a 14 or 28 Vdc power source. These voltages can be A+ switched power provided by the transponder or can be provided by the avionics buss. If using the avionics buss, protect the circuit with a one amp fuse or circuit breaker.

### **Parallel Data Connection**

The outline drawing provides electrical DA-15P connector pin/function information. Use this data when connecting the digitizer to the transponder. In some installations where older transponders are used, the transponder may not provide an “altitude disable” function. In this case, an instrument panel mounted switch for this function may be required.

**Serial Data Connection** (**Table VII** lists the pin assignments for the serial port connector.) Connect the **TxD1** or **RS485**<sup>3</sup> (transmit data) from the DA-15S D-Subminiature connector to the RxD (receive data) port on the GPS or other navigation device. Connect **TxD2** to the Shadin AMS2000 RxD Input. All grounds on the DA-15S D-subminiature connector are internally connected to ground and may be used to ground protocol pins, as well as provide data ground to the receiving GPS or other device. Pin 3 (RxD) of the 15-pin connector is used for calibration only. See **Table VII** for connector pin assignments and **§4.6** for software assigned protocols, and **§4.7** for calibration data. Shielded cable is recommended for both serial and parallel data wiring harnesses.

---

<sup>3</sup>The selected serial data protocol is transmitted simultaneously on both TxD1 and RS485. TxD2 will transmit the Shadin AMS2000 protocol only.

### **3.3 Serial Altitude Data Port Test Equipment**

The output of the serial port may, or may not be directly displayed by the GPS or other device receiving the serial data. There are several ways to test the output of the serial port:

1. Connect to an open serial port on a personal computer using serial data capture software such as PROCOMM™, VERSATERM™, SOFTWARE WEDGE™, TERMINAL (Windows® 3.x) or HYPERTERMINAL (Windows® 95 & 98).
2. Use a dedicated serial data test box such as the BLACK BOX™ RS232 Monitor.
3. Test for serial output using an oscilloscope to view the 9 Vdc square wave group transmitted about once a second.

### **3.4 Parallel ICAO Altitude Data Port Test Equipment**

The output of the parallel ICAO altitude data may be monitored by any number of transponder ramp test sets, which allow display of the altitude digitizer/encoder code. The IFR Model ATC-600A Portable Transponder Test Set is one example. Alternatively, the Trans-Cal Industries' ATS-200 may be used to display the parallel data.

## **Section 4.0 Calibration and Configuration**

### **4.1 Calibration Overview**

Reference: FAR 91.217; FAA Advisory Circular 43-6A  
**FAR 91.423; FAR 43-Appendix E and F**  
**FAA TSO-C88a; SAE AS8003**

This procedure will allow adjustment to the calibration curve of the SSD120-(XX)A-RS1 or SSD120-(XX)AE-RS1 as an aide in matching the digitizer output to a primary flight altimeter or NIST traceable pressure standard. The maximum allowed error between the primary flight altimeter and the altitude digitizer is  $\pm 125$  feet as required by TSO-C88a. All Trans-Cal digitizers are calibrated to within  $\pm 50$  feet of a NIST traceable pressure standard; however, the error allowed on altimeters at higher altitudes could lead to a combined error in excess of  $\pm 125$  feet. When the altitude digitizer is installed in an aircraft for use as the transponder's source of mode "C" information the digitizer must be recalibrated for correspondence to the aircraft's primary flight altimeter, as required by FAR 91.217 and 91.423. Model SSD120-(XX)A-RS1 and SSD120-(XX)AE-RS1 are designed to be field calibrated to meet this requirement, as per the procedure described in either §4.4 or §4.7.

The correspondence required for altitude digitizers is fully addressed in SAE Aerospace Standard AS8003 §3.11. The correspondence described by the SAE standard requires the digitizer to report altitude within  $\pm 125$  feet of the primary flight altimeter's reading when the pressure datum is set to 29.92 In. Hg., (1013 MB) absolute. The SAE standard also requires a transition accuracy of  $\pm 75$  feet of the nominal transition point for that altitude. A transition is defined as the point at which the digitizer changes from one altitude to the next, either increasing or decreasing altitude. The nominal transition point of the ICAO code occurs 50 feet prior to the altitude in question. See **Figure 1**.

There are two different methods used to affect the calibration of this device. The technician need only perform the method that is best suited for the application in question. *There is no need to perform both methods.* The digitizer may be adjusted using two potentiometers, which affect the span and reference of the pressure transducer. This device may also be adjusted utilizing an externally addressable EEPROM, which is configured to accept an alternate error curve entered to the digitizer via an IBM compatible PC.

The **Span Adjust** calibration (§4.4) is normally used in applications where the only a slight modification is required to bring the altitude digitizer curve up or down.

#### 4.1 Calibration Overview (continued)

The **Dynamic Calibration** procedure (§4.7) is an alternate method used to match the altitude digitizer to the primary flight altimeter or NIST standard. It assumes the digitizer and altimeter are connected as shown in the **Dynamic Calibration Block Diagram** and the technician may adjust the input pressure to run the digitizer and primary flight altimeter to the same altitude and then enter this altitude into an IBM compatible computer, which will transmit the correction to the digitizer's EEPROM. This calibration procedure differs from the **Span Adjust** procedure in that the adjustments are made at every 1000-foot interval and the Digitizer is adjusted at the 0 foot mark **NOT** the ICAO data nominal transition point.

#### 4.2 Required Equipment Span Adjust

(See span adjust block diagram.)

1. Primary Flight Altimeter.
2. +12 to 28VDC power supply.
3. A pitot-static test set, capable of exercising the altimeter and digitizer over a range of -1000 feet to the maximum altitude of the digitizer.
4. A ramp checker or test set capable of interrogating the transponder.  
(Optional: ATS-200 or equal device which will allow the display of the 100 foot resolution parallel altitude data.)

#### 4.3 Required Equipment Dynamic Calibration

(See dynamic calibration block diagram.)

1. Primary flight altimeter or NIST traceable pressure standard.
2. +12 to 28VDC power supply.
3. IBM compatible computer with an available serial port.
4. Software requirement: **Windows 98®** using **Hyper Terminal** Ver. 5.0 by Hilgraeve. (Available as a free download at <http://www.hilgraeve.com>) Or equal serial data capture software. See §3.3a.

(Software Note: The **Hyper Terminal** program, which is shipped with Windows 98®, will not function correctly. You must download **Version 5.0** or better, to calibrate this device.)

5. A pitot-static test set, capable of exercising the altimeter and digitizer over a range of -1000 feet to the maximum altitude of the digitizer.
6. *Optional*: ATS-200 or equal device which will allow the display of the 100 foot resolution parallel altitude data.

#### **4.4 Span Adjust Procedure**

1. Connect the pitot-static test equipment to the aircraft's static line, and connect the transponder test set per the manufacturer's recommendations. The digitizer's two altitude adjustment potentiometers are identified as L and H, representing low and high altitude. The low adjustment is closest to the edge of the housing, and the high adjustment is closer to the center of the housing.  
*(Note: Changing either potentiometer will affect the other. An adjustment made to correct the low transition point, will move the high transition point, and require an adjustment of the high potentiometer.)*
2. Apply power to the altitude digitizer/transponder.
3. Set the primary flight altimeter barometric pressure to 29.92 In. Hg. (1013 MB)
4. Interrogate the transponder with the ramp tester, while observing the digitizer ICAO altitude code, decrease pressure to the point where the altitude code just makes a transition to the maximum altitude encoded. Verify that the digitizer is within  $\pm 125$  feet of the primary flight altimeter's reading. If not, adjust the high potentiometer until the digitizer transition point is within  $\pm 30$  feet of the nominal transition point. (i.e. while ascending, the digitizer should transition from 29,900 feet to 30,000 feet at 29,950 feet nominally.)
5. Increase pressure until the digitizer's output just makes the transition from 100 feet to 0 feet. Verify that the altitude digitizer reports within  $\pm 125$  feet of the primary flight altimeter. If not, adjust the low potentiometer until the transition point is within  $\pm 30$  feet of the nominal transition point. (i.e. while descending, the digitizer should transition from +100 to 0 feet at +50 feet nominally.)
6. Repeat steps (4) and (5) until the  $\pm 125$  foot tolerance is achieved for both the maximum calibration altitude and the minimum calibration altitude.
7. Exercise the aircraft's static system over the operating range of the altitude digitizer and, with increasing and decreasing pressure, verify at a minimum of ten test points that the altitude digitizer and primary flight altimeter correspond within the  $\pm 125$  foot tolerance. Lightly tap the altimeter before each reading to eliminate friction. If correspondence is not achieved at any test point, the altimeter may require calibration.
8. Verify that the digitizer's output is disabled when the transponder is not in mode "C", or when the "Altitude Disable" switch is in the off position.

**CAUTION: Always refer to the altimeter and VSI manufacturer's data for maximum rate of climb or descent and any special test conditions which must be complied with.**



## **4.5 Hyper Terminal Set-Up on the IBM Compatible PC**

Boot up the computer and start the **Hyper Terminal** program. **Hyper Terminal** may be located in the **Programs** section or in the **Accessories** section under **Communications**.

Under the **New Connection** window. (Identifies the new connection.)  
Choose an icon then select an identifying title such as "Test."  
Select **OK** after you have made your choices.

Under the **Connect to** window (Selects the Com port to use.)  
-Choose **Connect Using Com 1** or whatever **Com** port you have chosen to use. After your selection click on **OK**.

Under the **Com ? Properties**, (Sets communication properties.)

Under the **Port Settings** tab, set the following:

Bits per second:	<b>9600</b>
Data bits:	<b>8</b>
Parity:	<b>None</b>
Stop Bits:	<b>1</b>
Flow Control:	<b>None</b>

Select **OK**

In the **Hyper Terminal** window select **File** then click on **Properties**.

Under the **Com ? Properties** window click on the **Settings** tab.

Set the following:

Function, arrow, ctrl keys to act as **Terminal Keys**.  
Emulation to **Auto Detect**

Under **ASCII Setup**

Set the following:

**Echo off.**  
**Wrap lines that exceed terminal width.**  
Select **OK**.

The software is now configured for operation.

## 4.6 Serial Port Software Configuration

Connect the digitizer to an IBM Compatible computer running **Hyper Terminal** as described in §4.3 and as shown in the **Configuration Block Diagram**.

Assign the serial port protocols as follows:

- 1.) Apply power to the interface adapter.  
Type **<P>** The interface adapter will respond with the software revision level and date then the program prompt **?>**
- 2.) Type **ADJ<enter>** The Adapter will respond with **A=**
- 3.) Type **P<enter>** Identifies the current serial port settings.

The Interface Adapter responds with a three-digit number as follows:

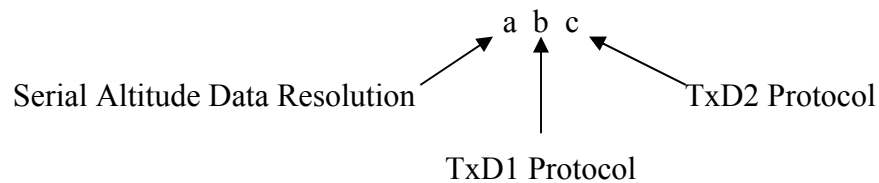

- (a) The first digit represents the serial altitude data resolution.
  - 0 = Use D-Sub connector protocol hardware jumpers.
  - 1 = 100 foot resolution on TxD1 and TxD2.
  - 2 = 10 foot resolution on TxD1 and TxD2.
- (b) The second digit represents the protocol selection for TxD1.
  - 0 = Use D-Sub connector protocol hardware jumpers.
  - 1 = UPS Aviation Technologies. 1200 bps.
  - 2 = Trimble/Garmin. 9600bps.
  - 3 = Northstar. 2400bps.
  - 4 = Magellan. 1200bps.
  - 5 = ARNAV. 9600bps.
- (c) The third digit represents the protocol selection for TxD2.
  - 0 = Use D-Sub connector protocol hardware jumpers.
  - 1 = UPS Aviation Technologies. 1200 bps.
  - 2 = Trimble/Garmin. 9600bps.
  - 3 = Northstar. 2400bps.
  - 4 = Magellan. 1200bps.

Example:

Type **P212<enter>** Defined as **10 foot** resolution on TxD1 and TxD2. **UPS Aviation Technologies** protocol transmitted on TxD1. **Trimble/Garmin** protocol transmitted on TxD2.

## **4.7 Dynamic Calibration Adjustment Procedure**

Reference: FAR 91.217; FAA Advisory Circular 43-6A  
**FAR 91.423; FAR 43-Appendix E and F**  
**FAA TSO-C88a; SAE AS8003**

This procedure will allow adjustment to the calibration curve of the SSD120-(XX)A-RS1 or SSD120-(XX)AE-RS1 as an aide in matching the digitizer output to a primary flight altimeter or NIST traceable pressure standard. This procedure differs significantly from the **Span Adjust Procedure** described in §4.4. The **Dynamic Calibration Procedure** makes adjustments to the altitude data stored in the digitizer's EEPROM. The technician may make adjustments to the digitizer error curve in 1000 foot increments, over the entire operating range with the single exception of the -1000 foot mark. The technician will make the adjustments at the 0 or whole altitude mark, **NOT** at the parallel data's nominal transition point. See **Figure 1**. The digitizer will automatically adjust the ICAO parallel altitude data to transition 50 feet prior to the 0 mark. (i.e. the digitizer's ICAO parallel altitude code will transition from 900 to 1000 feet while the serial altitude data is transmitting 950 feet.)

1. Construct a wiring harness per the wiring harness diagram 881404, Page 30.
2. Connect the digitizer, computer and altimeter or NIST standard as shown in the **Dynamic Calibration Block Diagram**, and energize.
3. Open the **Hyper Terminal** program as described in §4.5.
4. The digitizer output should now be displayed on the PC screen with 10-foot resolution.  
(You may use the **Hyper Terminal "Clear Screen"** function to remove any extra characters that may be cluttering the screen. Click on **Edit** then click on **Clear Screen**.)

**Note:** Backspace does not function in **Hyper Terminal**. If a typing error occurs, hit <enter> and begin again.

5. Set the altimeter barometric input to 29.92 In. Hg. Change the input pressure to -1000 feet and begin to compare the altitude digitizer output, as displayed on the computer, to the altimeter reading at every 1000-foot mark. When the digitizer output begins to differ from the altimeter by more than  $\pm 30$  feet begin to change the digitizer error curve. (§4.9 provides a table to for the technician to record the changes required and implemented.)

**(Note:** No digitizer correction is possible at the -1000 foot mark.)

#### **4.7 Dynamic Calibration Adjustment Procedure (continued)**

6. Type <enter> the digitizer will respond with ?>(current altitude)
7. Type **ADJ** <enter> the digitizer will respond with A=

**CAUTION: Always refer to the altimeter and VSI manufacturer's data for maximum rate of climb or descent and any special test conditions which must be complied with.**

8. Adjust the input pressure until the altimeter or NIST standard is exactly reading a 1000-foot mark. Note the difference between the digitizer and the altimeter and adjust as follows.

#### **Example:**

The altimeter reads 10,000 and the digitizer reads 10,080. Type “**S10 <enter>**” (S10 represents **Set 10,000 feet**) The digitizer will now output 10,000 feet based on the current input pressure. The PC will display the altitude at which the digitizer will make this change. In the example referenced above, the PC would display >**10000**.

9. Proceed to the next 1000-foot mark and repeat the procedure, as in step 8 above, until the entire operating range of the digitizer is completed.

#### **Note:**

- 1.) If no correction is required at an altitude simply do not enter a correction.
- 2.) Do not adjust the high or low potentiometers during this procedure.

You may quit the adjustment program at any time by typing “**Q**” twice; the digitizer output will then be displayed on the PC screen in normal operation mode.

10. After completing the above procedure you may examine the corrections entered into the EEPROM. Type “**D<enter>**” to dump the EEPROM data and read the current error curve on the PC screen. The following table should appear:

11.

00= 000	01= 000	02= 000	03= 000	04= 000	05= 000
06= 000	07= 000	08= 000	09= 000	10=-080	11= 000
12= 000	13= 000	14= 000	15= 000	16= 000	17= 000
18= 000	19= 000	20= 000	21= 000	22= 000	23= 000
24= 000	25= 000	26= 000	27= 000	28= 000	29= 000
30= 000	31= 000	32= 000	33= 000	34= 000	35= 000
36= 000	37= 000	38= 000	39= 000	40= 000	41= 000
42= 000	43= 000	44= 000	45= 000		
90= 000	91= 000	92= 000	93= 000	94= 000	95= 000
96= 000	97= 000	98= 000	99= 000	>current altitude	

The first two digits represent altitude x1000 feet and the last three digits after the equal sign represent the amount of error introduced at the altitude in feet.

**Note:** Fields **90=000** through **99=000** contain TCI calibration data and are not user accessible.

## 4.8 Configuration and Calibration Command List

Following is a list of commands, which will operate in the **ADJ** mode.

Top-Level Menu Commands	Action
<b>ADJ &lt;enter&gt;</b>	Enter <b>Adjustment</b> mode.
<b>Q</b>	<b>Quit</b> and resume normal operation.

Sub-Menu (ADJ) Commands	Action
<b>CLR &lt;enter&gt;</b>	<b>Clear</b> all EEPROM data.
<b>D &lt;enter&gt;</b>	<b>Dump</b> to list all EEPROM error data.
<b>P &lt;enter&gt;</b>	Displays current serial <b>Port</b> settings, see §4.6 <b>Serial Port Software Configuration</b> .
<b>Pabc&lt;enter&gt;</b>	<b>Port</b> protocol assign, see §4.6 <b>Serial Port Software Configuration</b> .
<b>Q</b>	<b>Quit</b> and return to top-level commands.
<b>Saa&lt;enter&gt;</b>	<b>Set</b> digitizer to 1K altitude ( <b>aa</b> ) mark at current input pressure. See §4.7 <b>Dynamic Calibration Adjustment Procedure</b> .

### NOTES:

1. Backspace does not function. If a typing error occurs hit **<enter>** and begin again.
2. Altitude values 90 to 99 in EEPROM contain factory calibration data and are not customer accessible.
3. A maximum error of  $\pm 499$  feet may be introduced at any one altitude.
4. **CLR** clears *all* error data in the EEPROM, and returns the digitizer to the original factory calibration.
5. **ERR** indicates syntax error.

#### 4.9 Error Correction Table

<b>Altitude</b>	<b>Correction</b>	<b>Altitude</b>	<b>Correction</b>
-1000		24000	
0		25000	
1000		26000	
2000		27000	
3000		28000	
4000		29000	
5000		30000	
6000		31000	
7000		32000	
8000		33000	
9000		34000	
10000		35000	
11000		36000	
12000		37000	
13000		38000	
14000		39000	
15000		40000	
16000		41000	
17000		42000	
18000			
19000			
20000			
21000			
22000			
23000			

## Digitizer Interconnection Tables

The following digitizer interconnections are provided as a quick reference only, and though they are correct to the best of our knowledge, always consult the latest installation, operation, and service bulletins from the equipment manufacturer.

*Note: These tables refer to the male DA-15P Male D-Subminiature connector. The female connector, DA-15S on the cover plate of the unit, is the serial data connector.*

**Table I**

SSD120 DA-15P Conn.	Function	Bendix/King KT76/78 Pin Number	Bendix/King KT76A/78A Pin Number	Bendix/King KXP Pin Number
1	D4	* <sup>4</sup>	* <sup>4</sup>	V
2	A1	6	M	G
3	A2	7	K	H
4	A4	9	J	J
5	B1	4	E	K
9	B2	1	C	L
10	B4	2	B	M
11	C1	3	D	P
13	C2	8	L	R
12	C4	10	H	S
6	Output Enable	Connect to aircraft ground.	Connect to aircraft ground.	Connect to aircraft ground.
8 or 14 * <sup>5</sup>	14 to 28Vdc Input.	Connect to aircraft's avionics buss protected by a fuse or circuit breaker.	Connect to aircraft's avionics buss protected by a fuse or circuit breaker.	Connect to aircraft's avionics buss protected by a fuse or circuit breaker.
15	Ground	Connect to aircraft ground.	Connect to aircraft ground.	Connect to aircraft ground.

<sup>4</sup> Data for this connection is not available at this time.

<sup>5</sup> Pins 8 and 14 are connected internally.



**Table II**

<b>SSD120 DA-15P Conn.</b>	<b>Function</b>	<b>Cessna RT359A, RT459A, RT859A Pin Number</b>	<b>Narco AT-150 AT-50, AT-50A Pin Number</b>	<b>Narco AT-6A AT-5, AT-6 Pin Number</b>	<b>Garmin GTX 327 Pin Number</b>
1	D4	10	* <sup>6</sup>	* <sup>6</sup>	18
2	A1	14	7	2	3
3	A2	13	6	4	5
4	A4	15	8	8	6
5	B1	19	12	9	9
9	B2	17	10	10	11
10	B4	16	9	11	12
11	C1	21	14	1	10
13	C2	18	11	3	4
12	C4	20	13	5	7
6	Output Enable	11	5	12	13 or 25 or aircraft ground
8 or 14 * <sup>7</sup>	14 to 28Vdc Input	9	18	13	14 to 28VDC Input
15	Ground	Connect to aircraft ground.	Connect to aircraft ground.	14	Connect to aircraft ground.

**Serial Data Connection for the Garmin GTX327 Transponder**

<b>SSD120-(XX)A-RS1 DA-15S Conn.</b>	<b>Function</b>	<b>GTX 327 25 Pin Conn.</b>
4	TxD to RxD	19
1 or 5 or 8	Ground	13 or 25
<b>Protocol, Connect pin 7 to ground.</b>		

To allow the **Garmin GTX 327** transponder to communicate with the SSD120-(XX)A-RS1 go to the **Setup Page** and set the **Altitude Source (ALT SRC)** to receive data in the Icarus RS232 format.

<sup>6</sup> Data for this connection is not available at this time.

<sup>7</sup> Pins 8 and 14 are connected internally.

**Table III**

<b>SSD120 DA-15P Conn.</b>	<b>Function</b>	<b>Edo-Air RT-777 Pin Number</b>	<b>Genave Beta 5000 Pin Number</b>	<b>Collins TDR 950 Pin Number</b>	<b>Radair 250 Pin Number</b>
<b>1</b>	D4	15	0	3	15
<b>2</b>	A1	7	4	12	7
<b>3</b>	A2	5	5	10	6
<b>4</b>	A4	3	6	7	13
<b>5</b>	B1	12	7	6	9
<b>9</b>	B2	13	8	5	10
<b>10</b>	B4	14	9	4	11
<b>11</b>	C1	8	10	8	14
<b>13</b>	C2	6	11	11	16
<b>12</b>	C4	4	12	9	12
<b>6</b>	Output Enable	2	3	Connect to aircraft ground.	19
<b>8 or 14 *<sup>8</sup></b>	14 to 28Vdc Input	Connect to aircraft's avionics buss protected by a fuse or circuit breaker.	2	Connect to aircraft's avionics buss protected by a fuse or circuit breaker.	22
<b>15</b>	Ground	2	Connect to aircraft ground.	Connect to aircraft ground.	Connect to aircraft ground.

<sup>8</sup> Pins 8 and 14 are connected together internally.

**Table IV**

SSD120 DA-15P Conn.	Function	Bendix TPR-2060 Pin Number	Bendix TR641A/B Pin Number	Wilcox 1014A Pin Number	UPS AT Apollo SL70 Pin Number
1	D4	* <sup>9</sup>	N	C	35
2	A1	4	A	k	13
3	A2	6	B	c	31
4	A4	8	C	W	12
5	B1	9	D	T	33
9	B2	10	E	L	14
10	B4	11	F	D	32
11	C1	3	H	P	16
13	C2	5	J	f	34
12	C4	7	K	Z	15
6	Output Enable	Connect to aircraft ground.	Connect to aircraft ground.	Connect to aircraft ground.	Connect to aircraft ground.
8 or 14 * <sup>10</sup>	14 to 28Vdc Input	Connect to aircraft's avionics buss protected by a fuse or circuit breaker.	Connect to aircraft's avionics buss protected by a fuse or circuit breaker.	Connect to aircraft's avionics buss protected by a fuse or circuit breaker.	Connect to aircraft's avionics buss protected by a fuse or circuit breaker.
15	Ground	Connect to aircraft ground.	Connect to aircraft ground.	Connect to aircraft ground.	Connect to aircraft ground.

**Serial Altitude Data Connection for the Apollo SL70 Transponder**

SSD120-(XX)A-RS1 DA-15S Conn.	Function	UPS AT SL70
4	TxD to RxD	4
1 or 5 or 8	Ground	3

To allow the UPS AT SL70 transponder to accept serial data from the SSD120-(XX)A-RS1 go to the **Test Mode** on the **SL79 Conf** page and set the **Altitude Source (ASrc)** to receive **Serial (Ser)** data. On the **BAUD** page select **1200**.

<sup>9</sup> Data for this connection is not available at this time.

<sup>10</sup> Pins 8 and 14 are connected internally.

**Table V**

<b>SSD120 DA-15P Conn.</b>	<b>Function</b>	<b>Becker Avionic Systems ATC3401 ATC2000</b>	<b>Becker Avionic Systems ATC4401</b>	<b>This column left blank intentionally.</b>	<b>This column left blank intentionally.</b>
<b>1</b>	D4	23	20		
<b>2</b>	A1	16	1		
<b>3</b>	A2	15	2		
<b>4</b>	A4	14	3		
<b>5</b>	B1	17	14		
<b>9</b>	B2	19	15		
<b>10</b>	B4	18	16		
<b>11</b>	C1	22	17		
<b>13</b>	C2	21	18		
<b>12</b>	C4	20	19		
<b>6</b>	Output Enable	24	25		
<b>8 or 14*<sup>11</sup></b>	+14 to 28Vdc	6	6		
<b>15</b>	Ground	24	25		

<sup>11</sup> Pins 8 and 14 are connected internally.

**Table VI**

<b>SSD120 DA-15P Conn.</b>	<b>Function</b>	<b>Bendix/King 560EGPWS</b>	<b>Bendix/King KMH 870 IHAS Processor</b>	<b>This column left blank intentionally.</b>
<b>1</b>	D4	No connection	18	
<b>2</b>	A1	12	11	
<b>3</b>	A2	52	10	
<b>4</b>	A4	33	9	
<b>5</b>	B1	14	14	
<b>9</b>	B2	34	13	
<b>10</b>	B4	73	12	
<b>11</b>	C1	32	17	
<b>13</b>	C2	13	16	
<b>12</b>	C4	72	15	
<b>6</b>	Output Enable	Connect to aircraft ground	Connect to aircraft ground	
<b>8 or 14*<sup>12</sup></b>	+14 to 28Vdc	Connect to avionics buss via circuit breaker	Connect to avionics buss via circuit breaker	
<b>15</b>	Ground	Connect to aircraft ground	Connect to aircraft ground	

<sup>12</sup> Pins 8 and 14 are connected internally.

**Table VII**

Serial Port Connector, 15-Pin D-Subminiature DA-15S

Pin	Function
1	Ground <sup>13</sup>
2	Ground for 10' resolution.
3	RxD (Calibration Only)
4	TxD1 <sup>14</sup>
5	Ground <sup>13</sup>
6	RS485B (+)
7	RS485A (-)
8	Ground <sup>13</sup>
9	Protocol Select see Table VIII.
10	Protocol Select see Table VIII.
11	Spare
12	TxD2 <sup>14</sup>
13	Do Not Connect
14	Spare
15	Spare

<sup>13</sup> Pins 1 and 5 and 8 are internal grounds provided for protocol selection and serial data ground.

<sup>14</sup> **TxD1** and **RS485** port will transmit the protocol selected by grounding the pins above.  
**TxD2** will transmit the Shadin AMS2000 protocol only.

**Table VIII**

Protocol Selection: DE-15S D-Subminiature Connector Function Table

<b>Protocol Selection</b>	<b>Pin 2</b>	<b>Pin 9</b>	<b>Pin 10</b>
<b>UPS AT 100' resolution, 1200bps. UPS AT 10' resolution, 1200bps.</b>	Open Gnd.	Open Open	Open Open
<b>Trimble/Garmin, 100' resolution, 9600bps. Trimble/Garmin, 10' resolution, 9600bps.</b>	Open Gnd.	Open Open	Gnd. Gnd.
<b>Northstar/Garmin, 100' resolution, 2400bps. Northstar/Garmin, 10' resolution, 2400bps.</b>	Open Gnd.	Gnd. Gnd.	Open Open
<b>Magellan, 100' resolution, 1200bps. Magellan, 10' resolution, 1200bps.</b>	Open Gnd.	Gnd. Gnd.	Gnd. Gnd.
<b>ARNAV Systems (Software selectable ONLY)</b>	Open	Open	Open

### GPS/MFD Connection Data

Given the speed with which new GPS units are entering the market, it is impossible to provide data on every device. The following digitizer/GPS interconnections are provided as a quick reference only, and though they are correct to the best of our knowledge, always consult the latest installation, operation, and service bulletins from the GPS manufacturer.

### UPS Aviation Technologies (IIMorrow)

#### Apollo Model GX50, GX60, GX65

Apollo GX50, GX60, GX65 Signal	Apollo 37 Pin D-Sub Connector	SSD120-(XX)A-RS1 DA-15S D-Sub Connector
RxD2	21	4 or 9
Ground	20	1 or 5 or 8
		<i>Optional, jumper pin 2 to ground for 10' resolution.</i>

#### Apollo GX50, GX60, GX65 Software Configuration

In test mode, rotate the **Large** knob to select serial port configuration **RX**. Press **SEL**, rotate the large knob to select the **RxD2** port, rotate the small knob to select **AltEnc** input.

#### Apollo Model MX20 Multi Function Display

Apollo MX20 Signal	Apollo 37 Pin D-Sub Connector	SSD120-(XX)A-RS1 DA-15S D-Sub Connector
RxD2	21	4 or 9
Ground	3	1 or 5 or 8
		<i>Optional, jumper pin 2 to ground for 10' resolution.</i>

#### Apollo MX20 Software Configuration

Under External Data Source set altitude source to **Port 2**.



## Trimble

### Trimble 2101 Approach Plus GPS Receiver

Trimble Signal	Trimble 2101 Port 1	Trimble 2101 Port 2	SSD120-(XX)A-RS1 DA-15S D-Sub Connector Pin
RxD+	7	24	1 or 5
RxD-	8	36	4
Ground	3 or 20	3 or 20	1 or 5
			Protocol assignment, jumper pin 7 to ground on pins 1 or 5 or 8
			<i>Optional, jumper pin 2 to ground for 10' resolution.</i>

#### **Trimble 2101 Approach Plus GPS Receiver Software Configuration - Installation Setup**

Access the 2101 installation setup submenu and go to the SERIAL I/O SETUP. Select the GPS serial port which is to receive the pressure altitude data,

**SERIAL-1 IN** or **SERIAL-2 IN**.

Set data format to **ENCODER**.

### 2101 I/O Approach Plus GPS Receiver

Trimble Signal	Trimble 2101 I/O Serial Port 1	Trimble 2101 I/O Serial Port 2	SSD120-(XX)A-RS1 DA-15S D-Sub Connector Pin
RxD+	J1-7	J1-24	1 or 5
RxD-	J1-8	J1-36	4
Ground	J1 - 3 or 20	J1 - 3 or 20	1 or 5
			Protocol assignment, jumper pin 7 to ground on pins 1 or 5 or 8
			<i>Optional, jumper pin 2 to ground for 10' resolution.</i>

#### **2101 I/O Approach Plus GPS Receiver Software Configuration - Installation Setup**

Access the 2101 installation setup submenu and go to the SERIAL I/O SETUP. Select the GPS serial port, which is to receive the pressure altitude data, **SERIAL-1 IN** or **SERIAL-2 IN**. Set data format to **ENCODER**.

**Garmin International**

**Garmin 400 Series GPS Devices**

<b>Garmin 78 Pin Conn. (P4001)</b>	<b>SSD120-(XX)A-RS1 DA-15S Conn.</b>
57	4
77 or 78	1 or 5
	Protocol, jumper pin 7 to ground.
	<i>Optional, jumper pin 2 to ground for 10' resolution.</i>

**Garmin 400 series GPS software configuration**

To allow the **Garmin 400 series GPS** to communicate with the SSD120-(XX)A-RS1 go to the **Main RS232 Config** page and set channel 1 input to **Icarus-alt**.

**ARNAV Systems, Inc.**

**ARNAV Systems 5000 Series Multi-Function Display**

<b>ARNAV 5000 25 Pin Connector</b>	<b>SSD120-(XX)A-RS1 DA-15S Conn.</b>
<b>15</b>	<b>4</b>
<b>13 or 25</b>	<b>1 or 5 or 8</b>
	Protocol, Software select ARNAV protocol see §4.6.

**ARNAV Systems GPS-505/506/512 GPS Sensor**

<b>ARNAV GPS-505/506/512 DB-25 Connector</b>	<b>SSD120-(XX)A-RS1 DA-15S Conn.</b>
<b>8</b>	<b>4</b>
<b>9</b>	<b>1 or 5 or 8</b>
	Protocol, Software select ARNAV protocol see §4.6.

**ARNAV Systems DR-100 WxLink Receiver/ Multiplexer**

<b>ARNAV DR-100 25 Pin Connector</b>	<b>SSD120-(XX)A-RS1 DA-15S Conn.</b>
<b>10</b>	<b>4</b>
<b>13 or 25</b>	<b>1 or 5 or 8</b>
	Protocol, Software select ARNAV protocol see §4.6.

**SSD120-(XX)A-RS1 Software Configuration Note ARNAV Systems Devices**

The SSD120-(XX)A-RS1 *must* be software configured per §4.6 to operate with ARNAV system devices. Ensure that all hardware jumpers are removed from the 9-pin connector. Hardware jumpers on the 15-pin D-Subminiature Connector (DA-15S) *will override* any software settings.

**Temperature vs. Warm-up Time Figure 3**

**Figure 3  
Temperature vs. Warm-up Time**

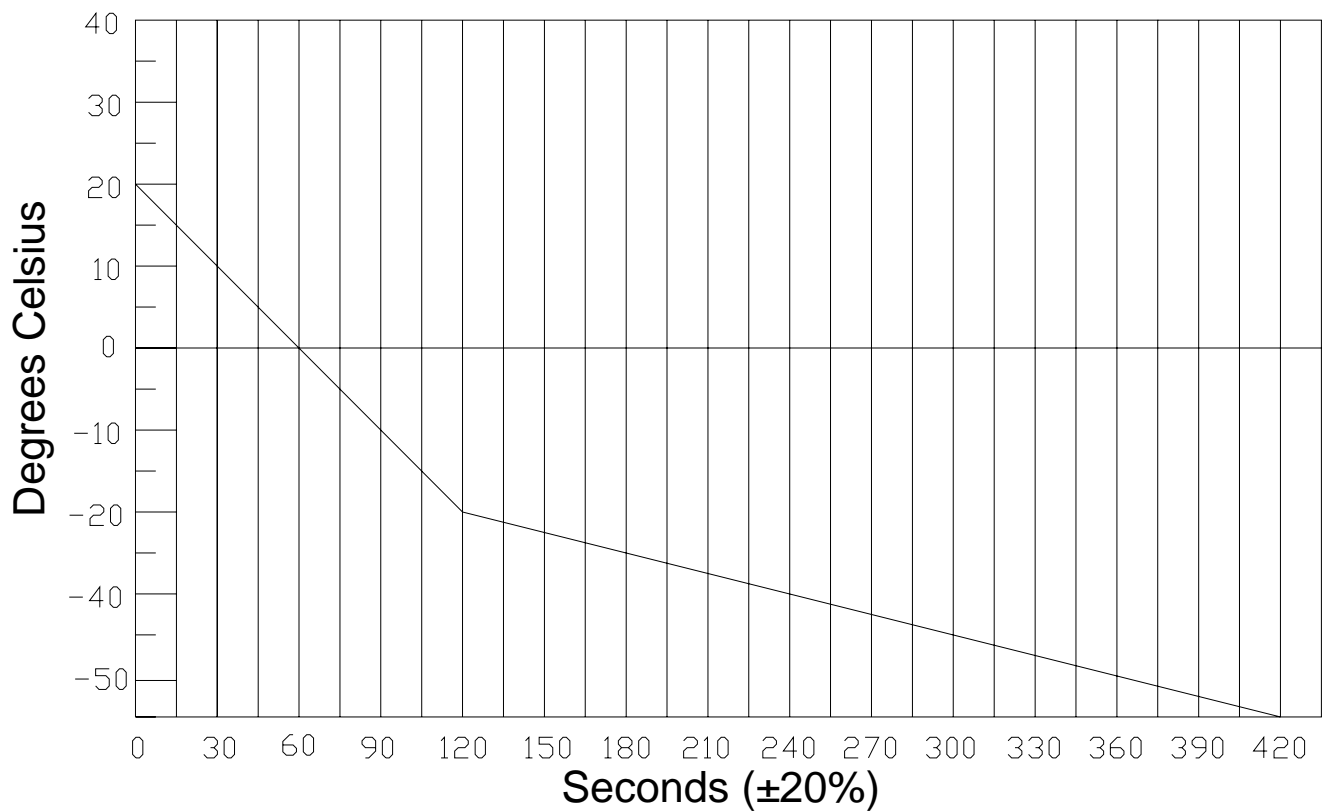

**Shadin Installation Wiring Diagram**

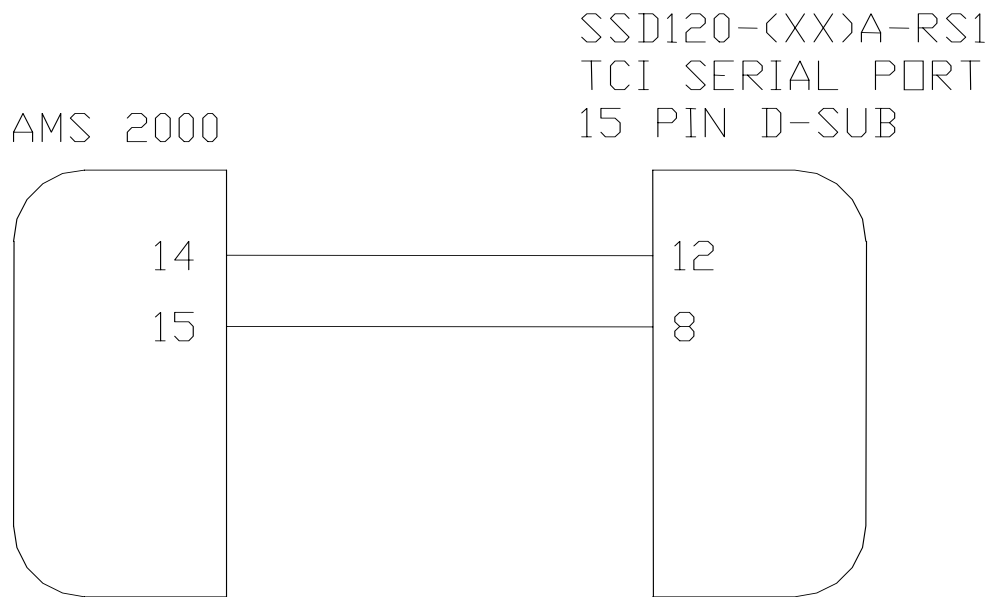



**Wiring Harness Diagram P/N: 881404**

Wiring Harness Diagram  
for Calibration via  
SSD120-(XX)A( )-RS1  
Serial Port

IBM PC with 9 Pin D-Sub.

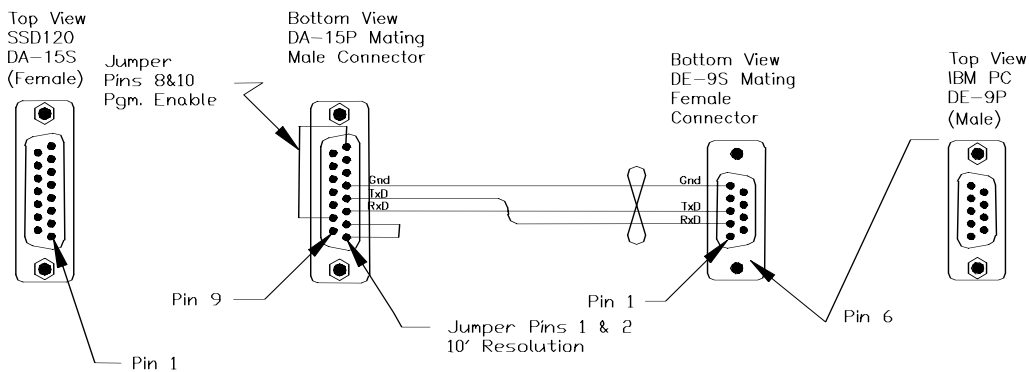

IBM PC with 25 Pin D-Sub.

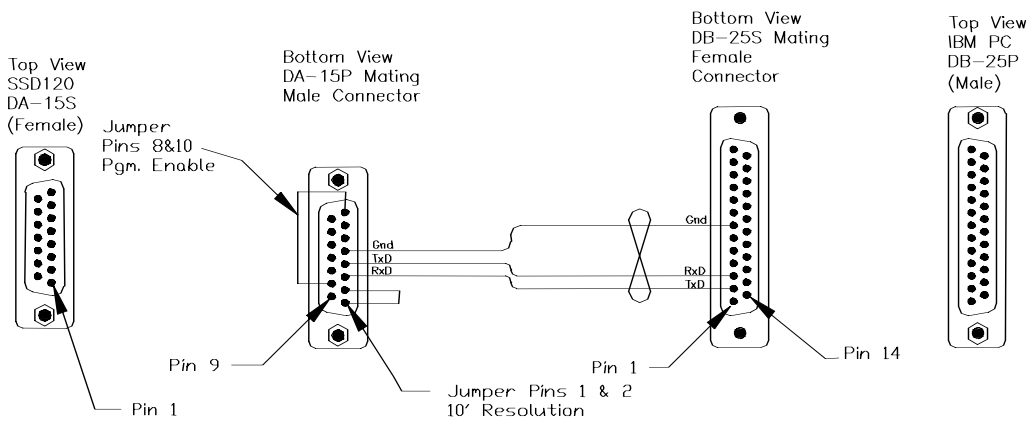

Harness available from Trans-Cal Ind.

# Span Adjust Block Diagram

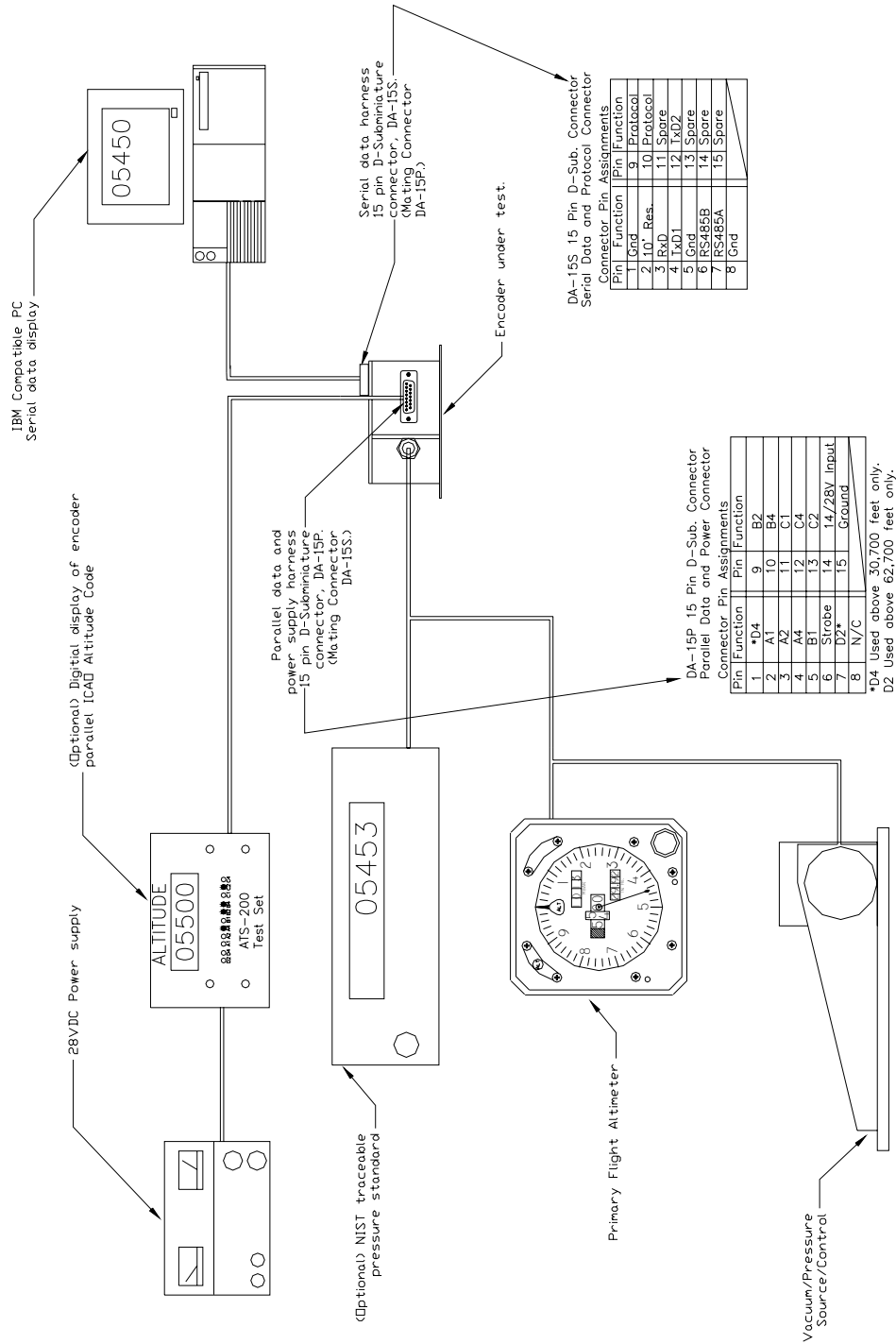

Block Diagram Span Adjust.  
Model SSD120-30A( )-RS1thru 42A



## NARCO Transponder Installations

# Narco AT-50 and AT-50A Installations

The Narco AT-50 or AT-50A transponder will not accept data from the Trans-Cal SSD120-(XX)A until the following modifications have been completed:

1. The strobe modification as outlined in Narco service bulletin no. AT-50A-5 dated 19 February 1975 has been performed on the transponder.
2. A modification to the Trans-Cal SSD120-(XX)A removing the data line decoupling capacitor network.

The SSD120-(XX)A may be ordered from the factory with Mod. 1 completed, or the altitude digitizer may be modified in the field as outlined below.

### Instructions for field modification:

1. Remove the 4 screws, lockwashers and cover plate. Do not remove the D-Sub serial data connector.
2. Remove and discard the C1 capacitor network (refer to figure 1 below.) The network may be removed using a pair of pliers to slowly rock the network back and forth until it breaks away.
3. Replace the cover plate, 4 lockwashers and screws.
4. A modification label is located on the side of the altitude digitizer. Using an indelible ink pen, place an "X" in the box identifying modification 1 as complete.

Figure 1

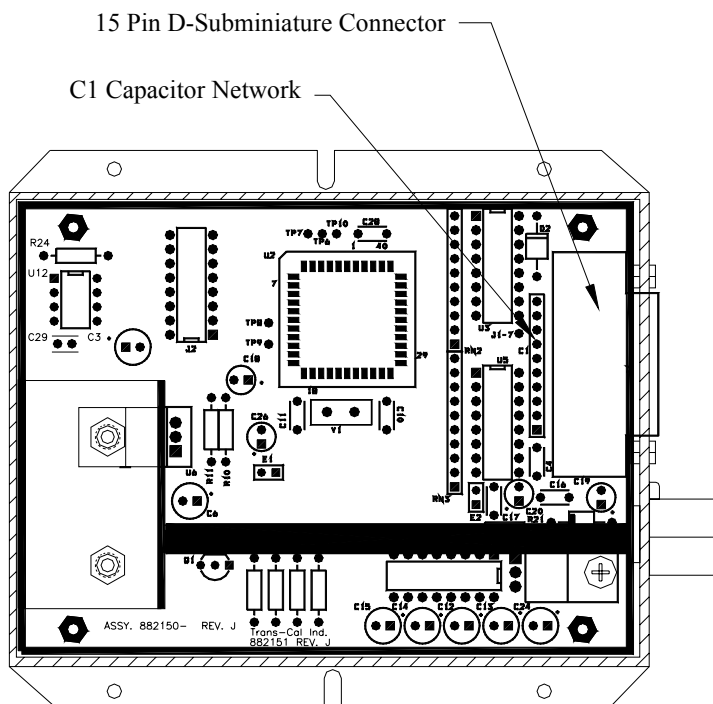

Trans-Cal Industries, Inc.  
 Solid State Altitude Digitizer  
 Part Number Ordering Information

SSD120-XX X X-XXXX

Max. Operating Altitude (Feet)	
30,000	-30
35,000	-35
42,000	-42
50,000	-50
62,000	-62
65,000	-65
80,000	-80
85,000	-85
100,000	-100

Model Nomenclature	Identifier
Encoder / Digitizer	A
Modular Encoder	M
Servo Module	SM

Operating Temperature Range	
Blank	-20° to +70°C
E	-55° to +70°C

Additional Ports and Features	
-RS232	Dual RS232 Ports
-RS	RS485 and Dual RS232 Ports
-RS1	RS485 and 1' Resolution on Tx/D2

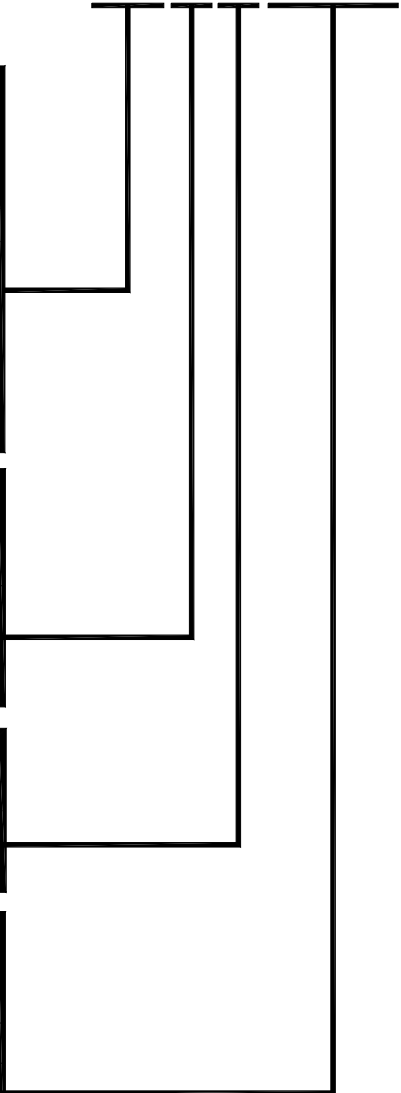

Part Number Example: SSD120-42AE-RS232  
 Note: On models operating at 50,000 to 100,000 feet, dual RS232 ports are included as a standard feature.

**WARRANTY REGISTRATION**

Trans-Cal Industries warrants each Model SSD120-(XX)A(E)-RS1 Solid State digitizer / serializer to be free of defects in workmanship and materials for a period of 42 months after purchase. This warranty applies to the original purchaser of the instrument.

Trans-Cal's obligation under this warranty is limited to repairing or replacing any unit returned to Trans-Cal during the life of this warranty provided:

- (1) The defective unit is returned to us, **transportation pre-paid.**
- (2) Prior approval is obtained from Trans-Cal.
- (3) The unit has not been damaged by misuse, neglect, improper operation, accident alteration or improper installation.

Trans-Cal **DOES NOT** reimburse labor costs on warranty repairs. Trans-Cal Industries will be the sole judge as to the cause of the malfunction and wherein the responsibility lies. No other obligation or liability is expressed or implied.

For the above warranty to become effective, the attached registration card **must** be completed and returned to Trans-Cal Industries, properly filled out and signed by the dealer selling or installing this equipment.

Mail to: Trans-Cal Ind., Inc., 16141 Cohasset St., Van Nuys, CA 91406

----- cut here -----

**MODEL: SSD120-(     )A(E)-RS1     SERIAL NO: RS-**\_\_\_\_\_

**AIRCRAFT:**\_\_\_\_\_ **NUMBER:**\_\_\_\_\_

**OWNER:**\_\_\_\_\_

**ADDRESS:**\_\_\_\_\_

**CITY:**\_\_\_\_\_ **STATE:**\_\_\_\_\_ **ZIP:**\_\_\_\_\_

**DEALER:**\_\_\_\_\_

**INSTALLED BY:**\_\_\_\_\_

**LICENSE NO:**\_\_\_\_\_

**INSTALLATION DATE:**\_\_\_\_\_

**I hereby certify the above instrument was installed in accordance with the instructions of Trans-Cal Industries, and the installation was done in a workmanshiplike manner. I further certify the instrument was properly working on the above date.**

**SIGNED:**\_\_\_\_\_

**PRINT NAME:**\_\_\_\_\_